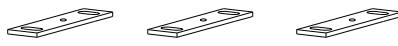
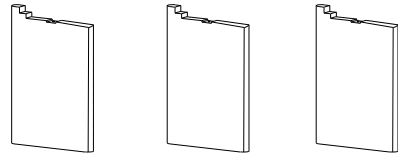

ASSEMBLY INSTRUCTIONS

Part List

ITEM CODE-281-018

Label	Picture	Description	Qty.
1.		MARBLE TOP	1 Pc.
2.		IRON PLATE	3 Pcs.
3.		WDN LEGS	3 Pcs.

HARDWARE LIST :

Qty.

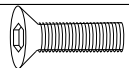
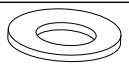
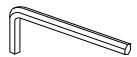
Label	Picture	Description	Qty.
A		ALLEN BOLT	9 Pcs.
B		WASHER	6 Pcs.
C		ALLEN KEY	1 Pc.

STEP-1

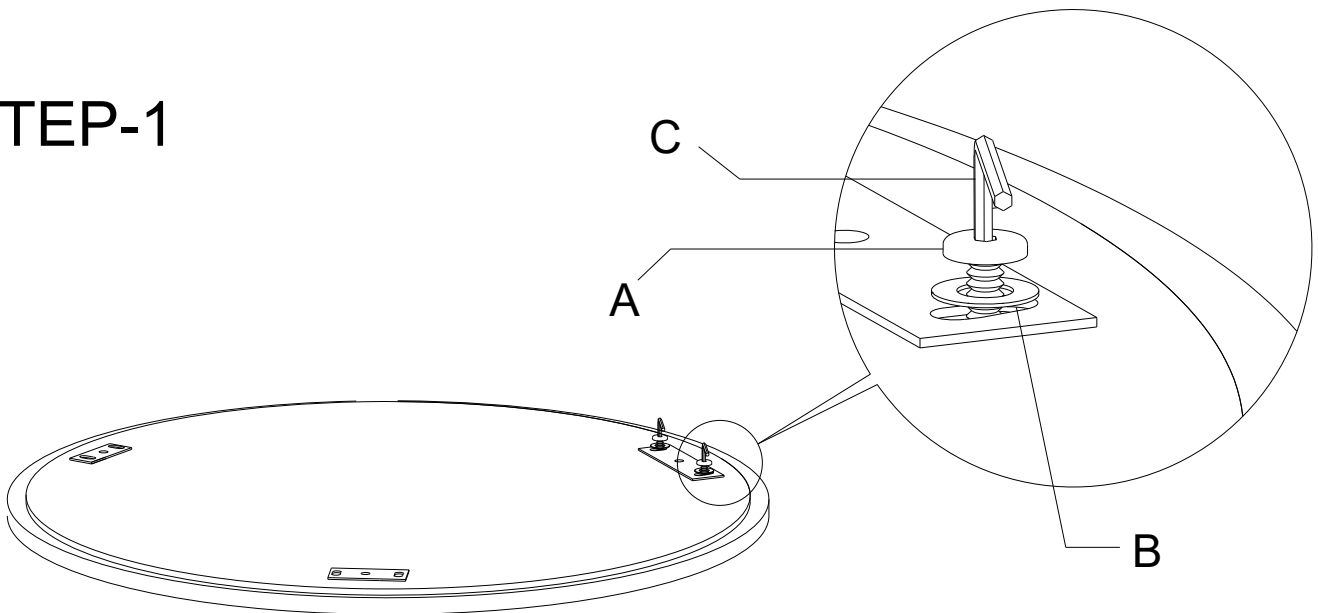

STEP-2

Fix metal plate on the wooden leg as per reference image

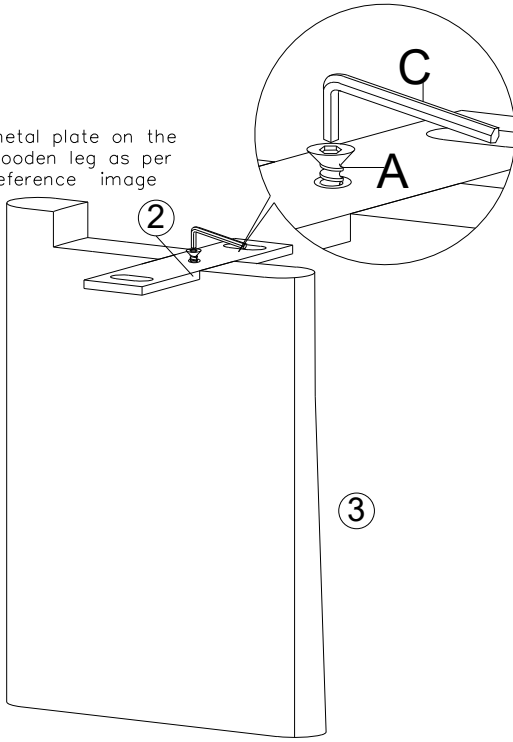

Tighten the allen bolt as per reference image.

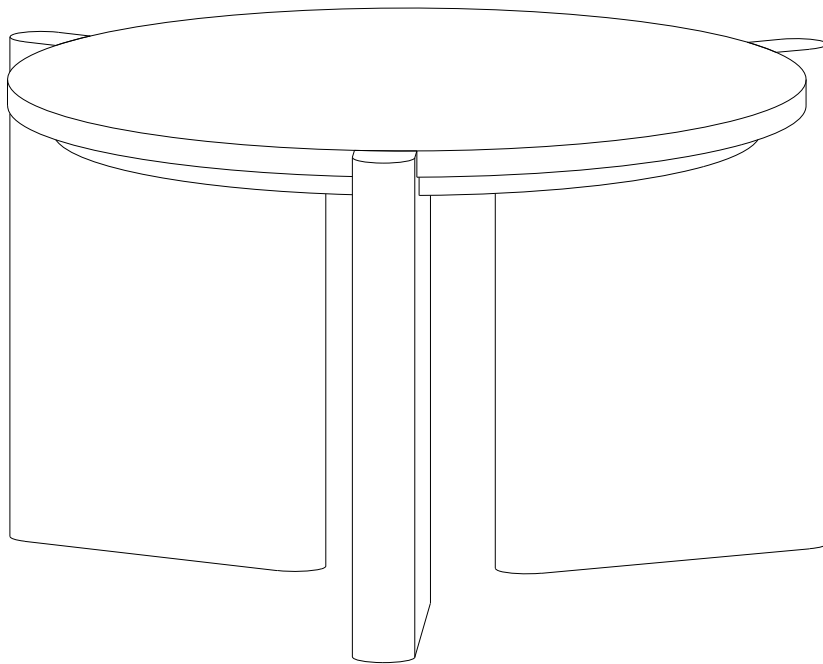
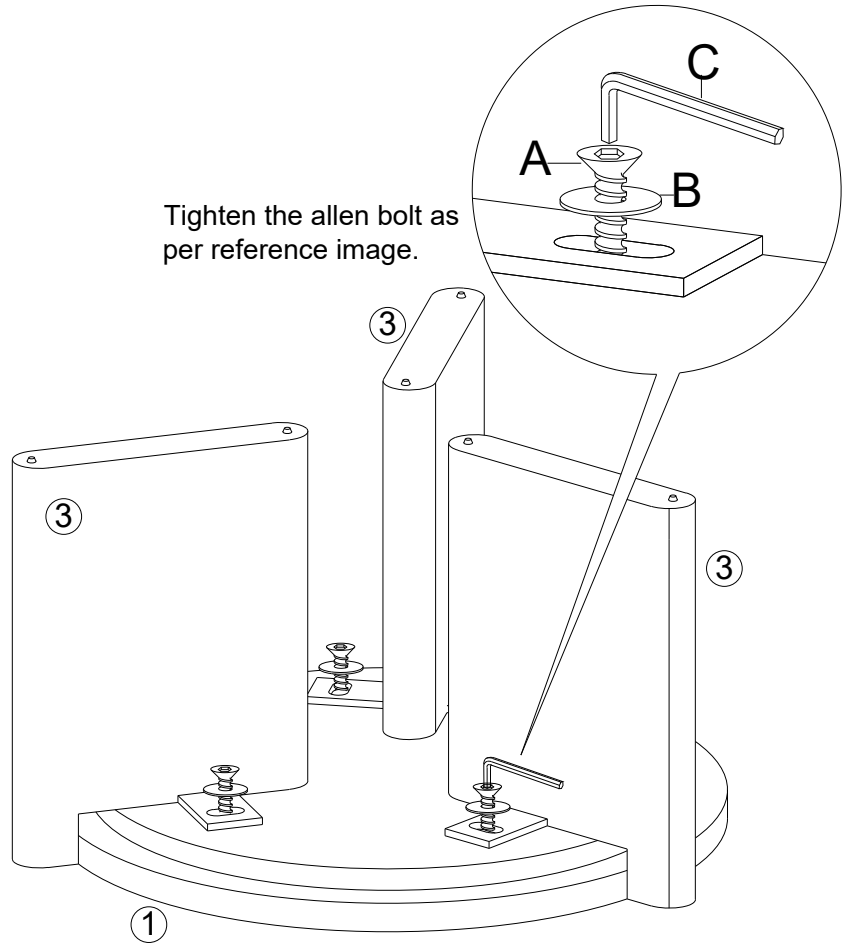

COMPLETELY ASSEMBLED