

Assembly Instruction

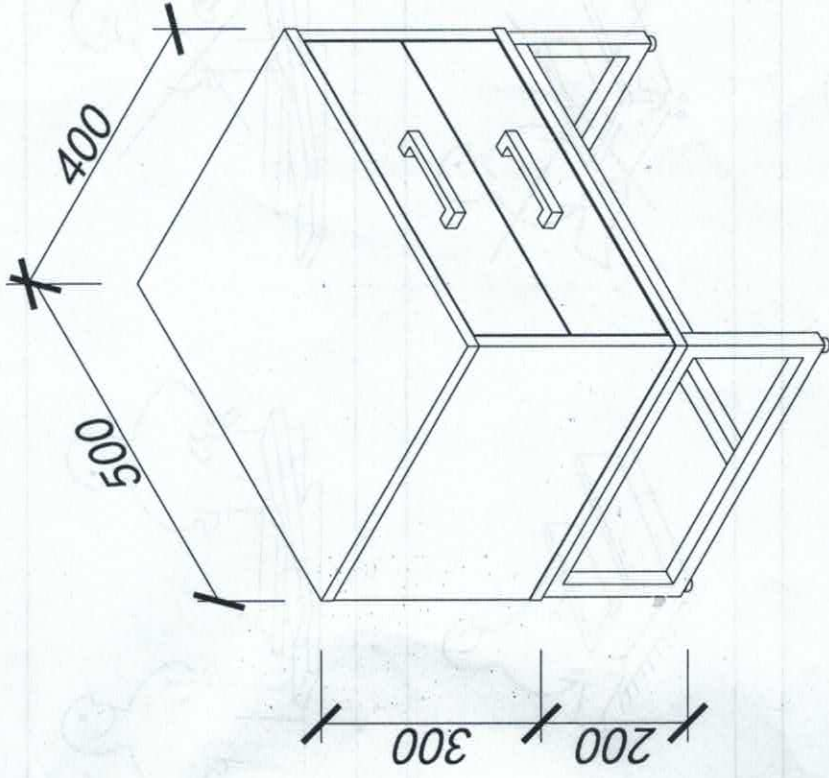

Panel No	Panel Sizes	Quantity
1	500*400*16	1
2	500*400*16	1
3	268*399*16	1
4	268*399*16	1
5	477*279*5	1
6	462*131*16	2
7	416*80*12	2
8	350*80*12	2
9	350*80*12	2
10	427*349*5	2

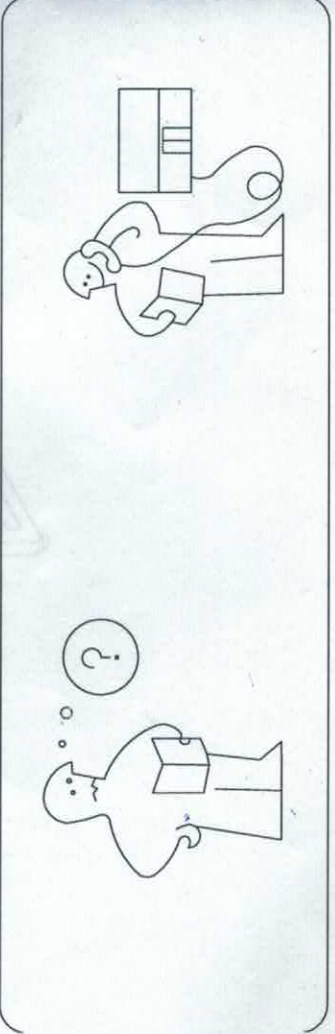
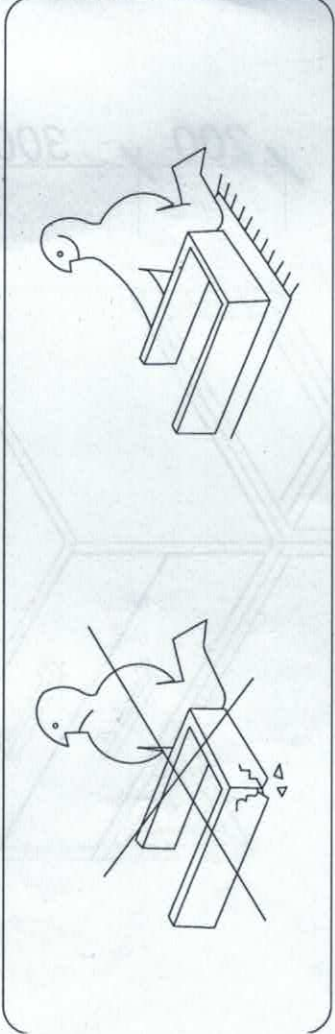
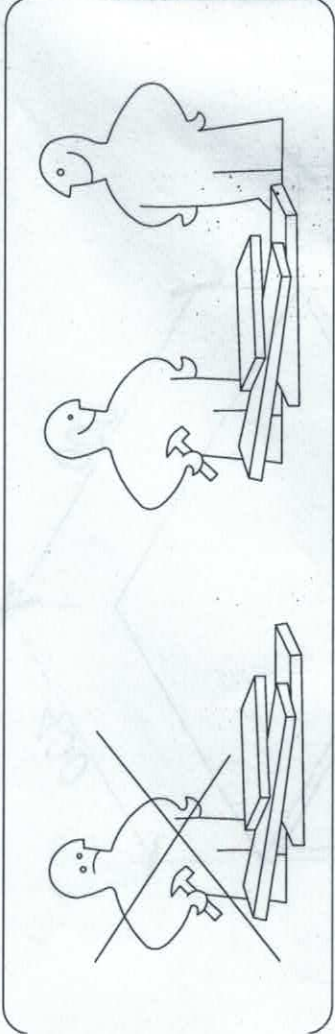
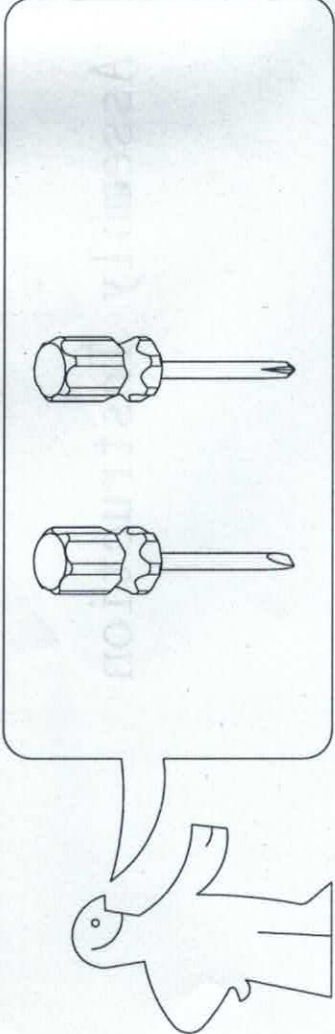
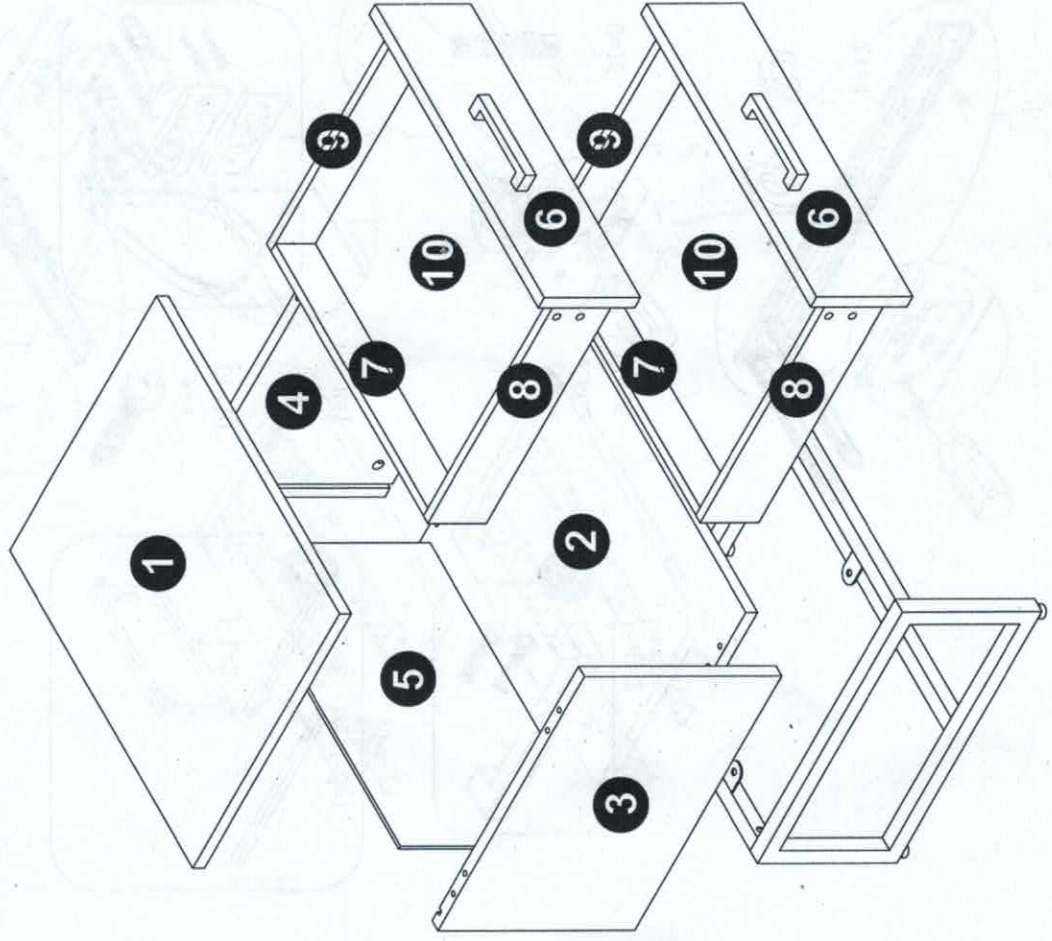

Fittings



A=8



B=8



C=8



D1=24



E=4

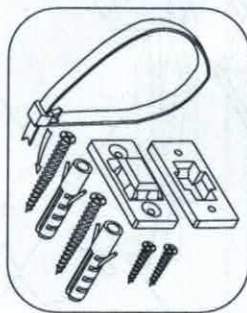

F=1



G1=10



H=1

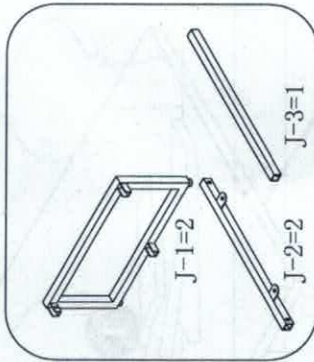

J-1=2

J-2=2

J-3=1



O=16



P=16



V1=16

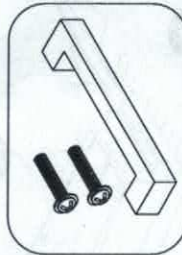

U=2



Z1=4



Z2=4



N=2

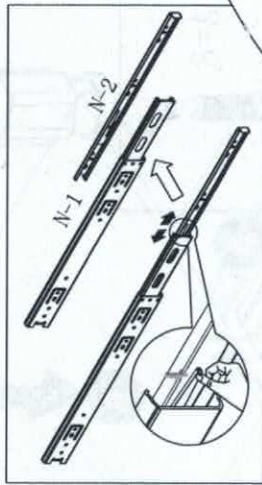

N-1=4



V2=8

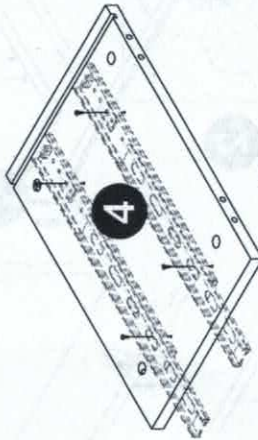

4

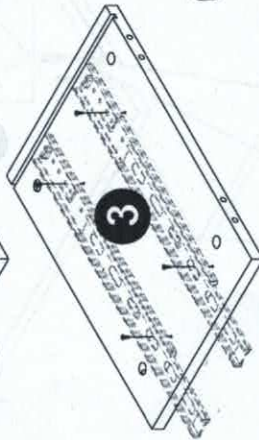

3

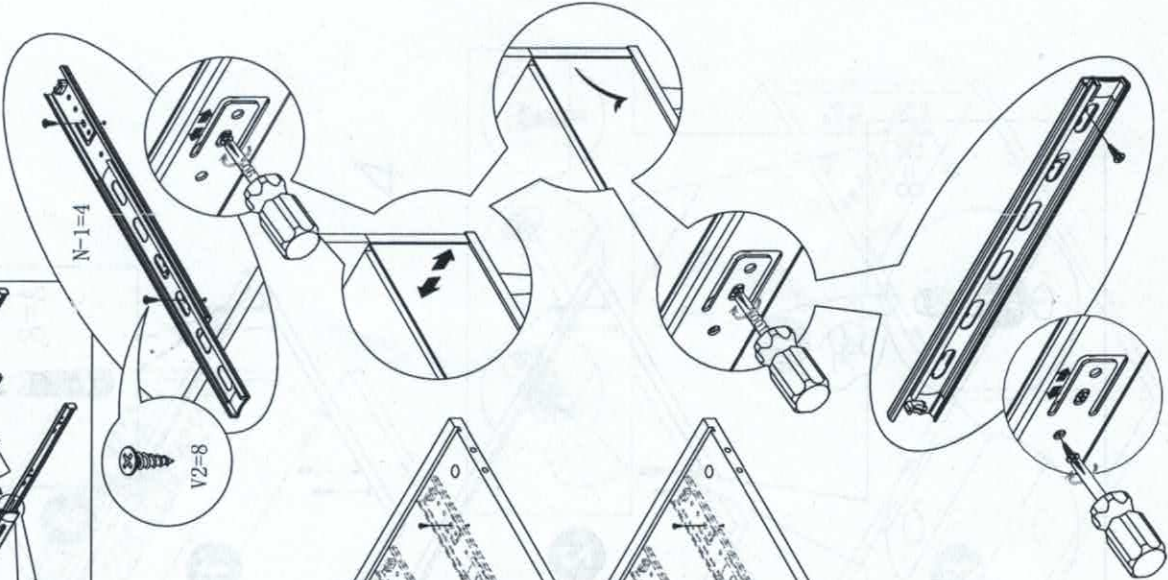

2

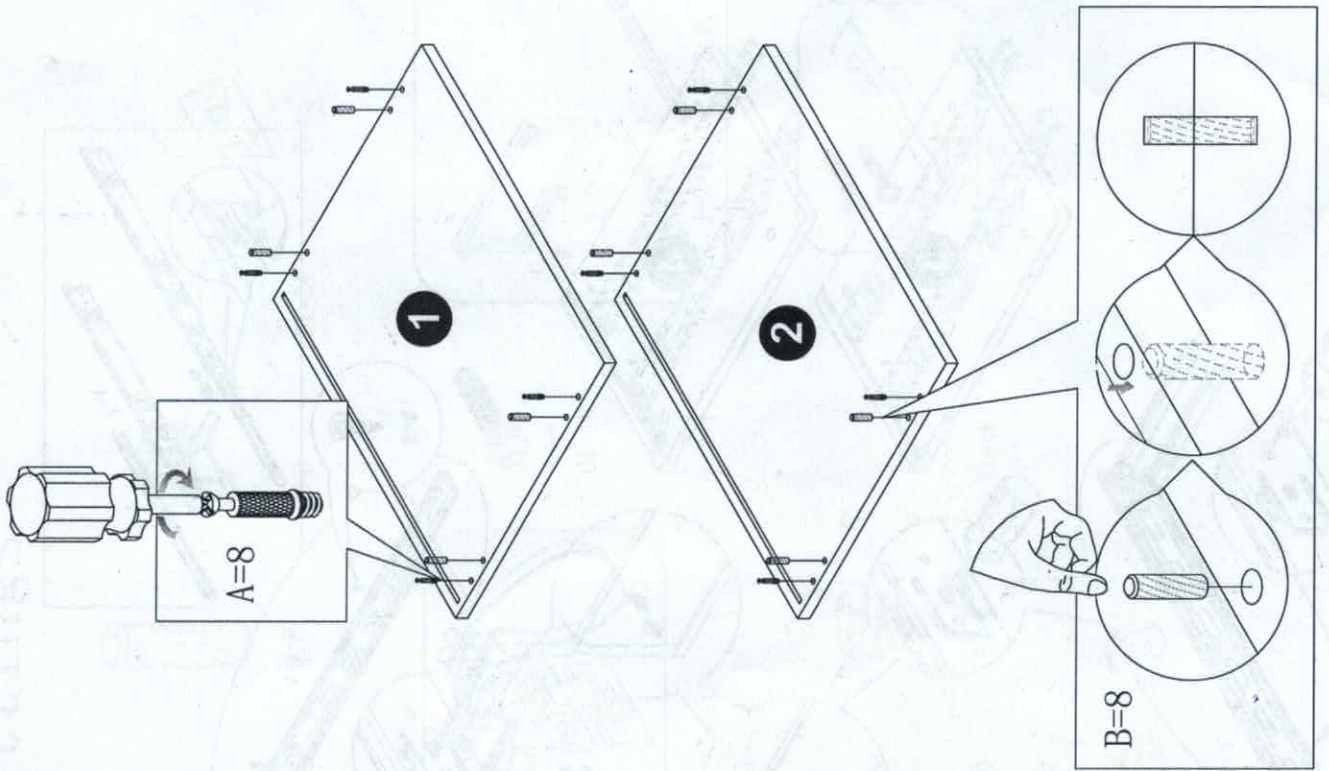

3

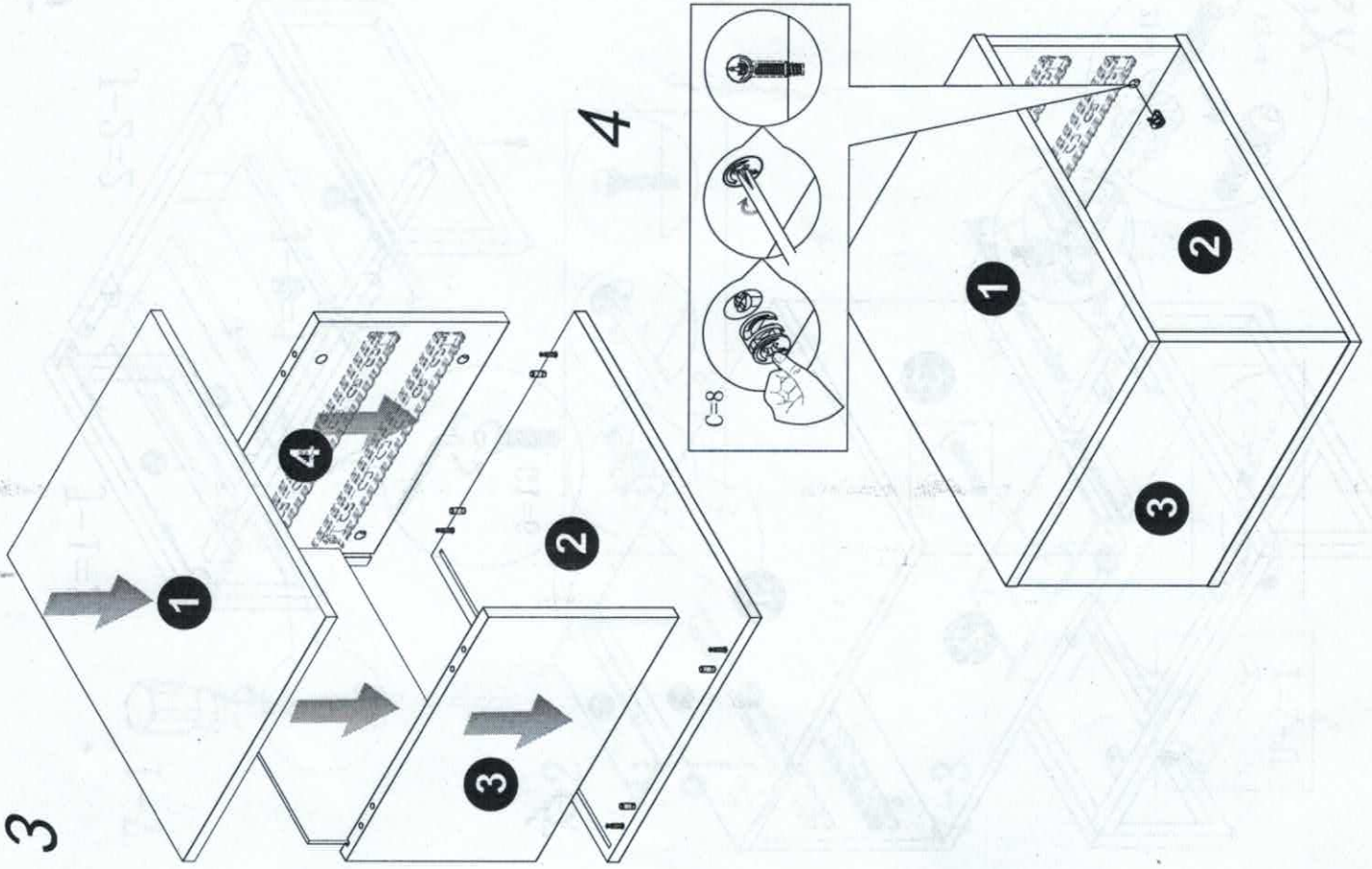

5

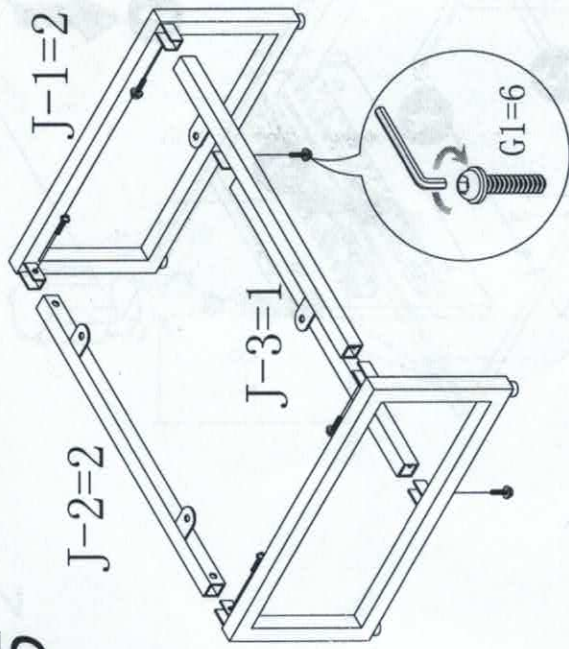

6

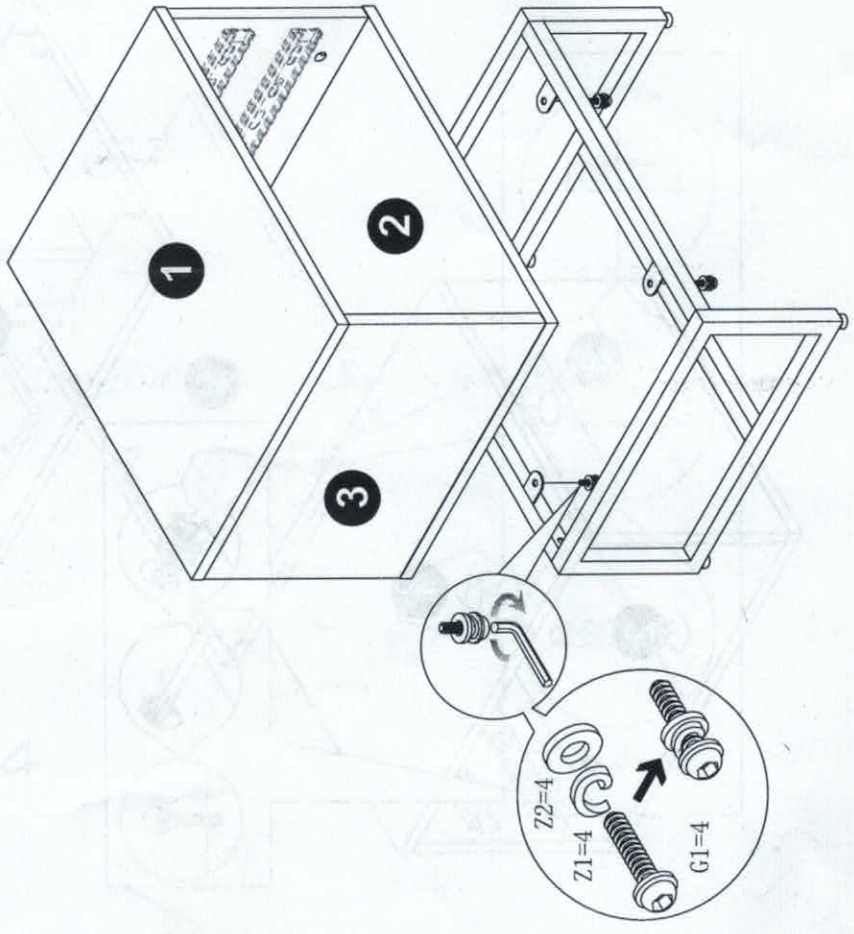

7

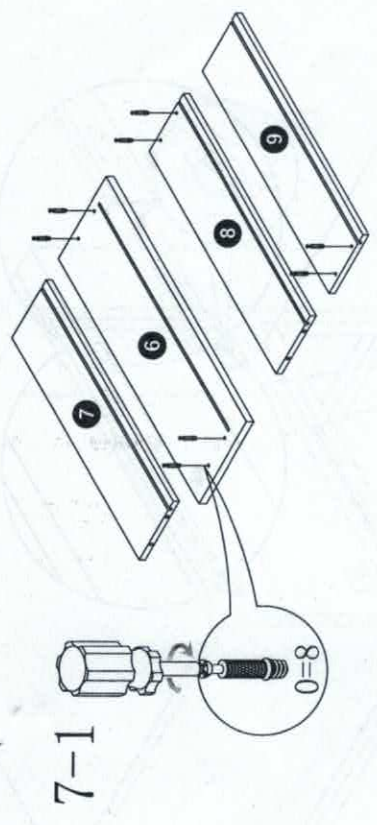

7-1

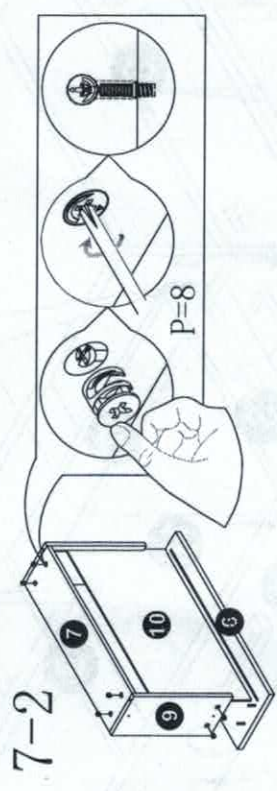

7-2

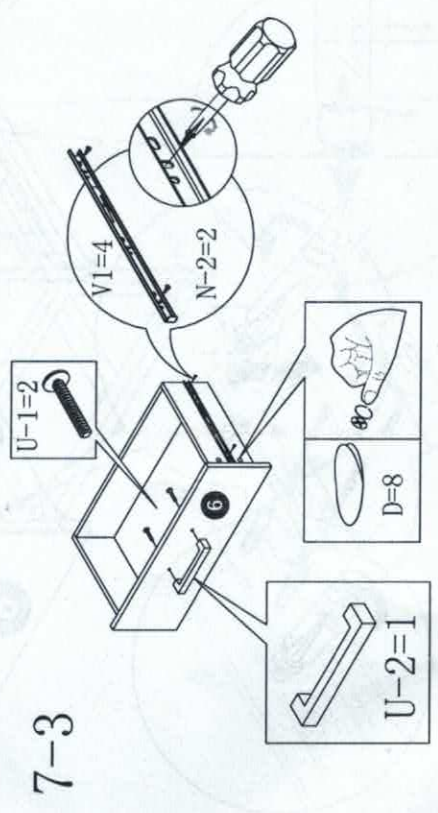

7-3

X2

