

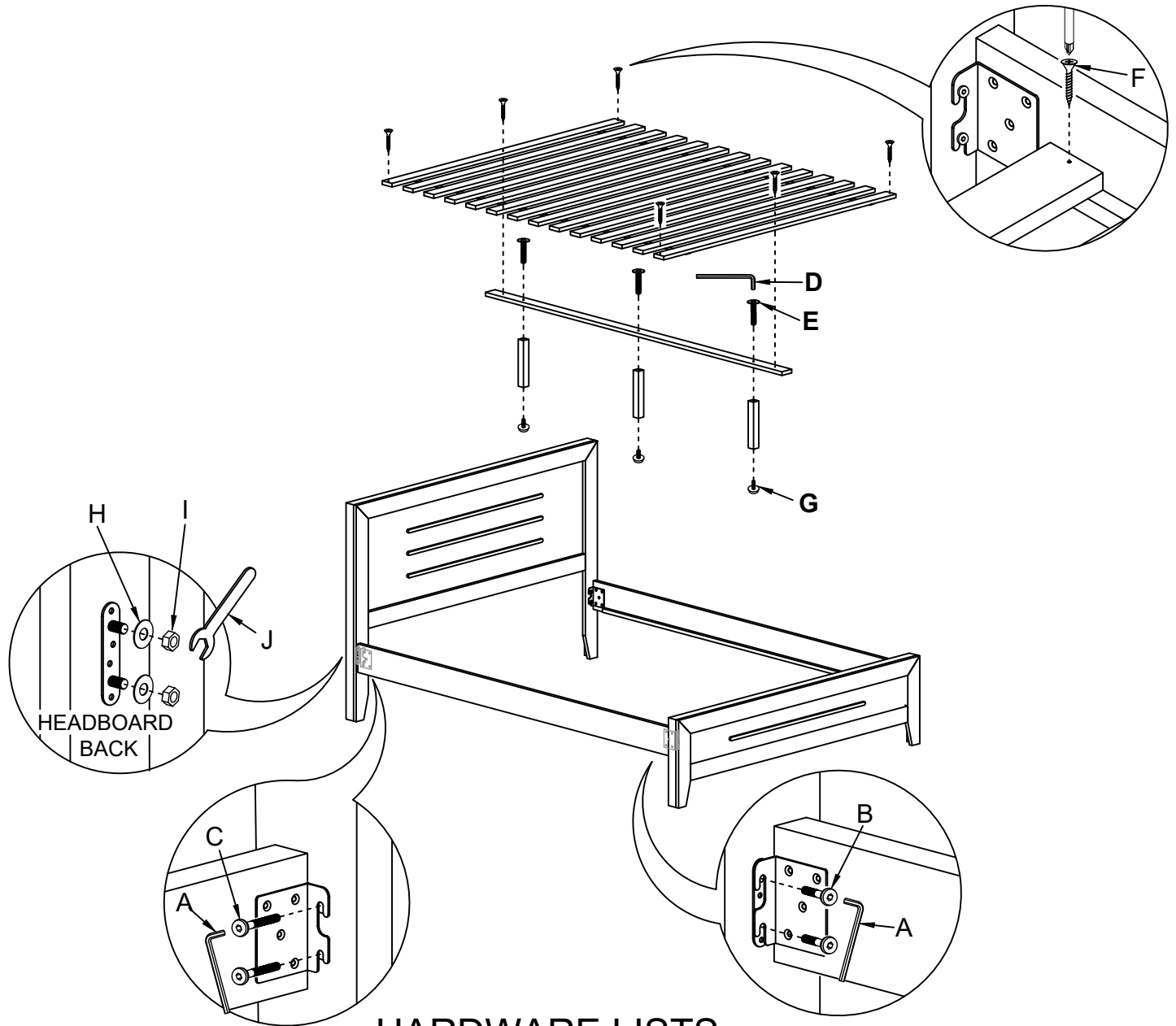









ASSEMBLY INSTRUCTION

Thank you for purchasing this quality product. Please check all packing material carefully which may have come loose inside the carton during-shipment. Identify and count all parts referring to the Part List below.

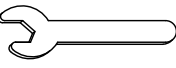

HARDWARE LISTS

NO	DESCRIPTION	QTY	NO	DESCRIPTION	QTY
A	 ALLEN KEY M5	1	F	 CSK SCREW M4 32MM	6
B	 JCBB BOLT M8 20MM	4	G	 ADJUSTABLE LEG	3
C	 JCBB BOLT M8 40MM	4	H	 M8 WASHER	4
D	 ALLEN KEY M4	1	I	 M8 HEXAGON NUT	4
E	 JCBC BOLT M6 30MM	3	J	 WRENCH	1