











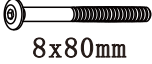

ASSEMBLE INSTRUCTION (AI)

MODEL : T-1426

ASSEMBLY TIPS: Remove hardware from box and sort by size. Check that all hardware and parts are present before assembling. Following the instruction below in proper sequence to ensure fast, easy and correct assembly.

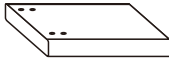

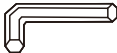
WARNING: DO NOT FULLY TIGHTEN ALL BOLTS UNTIL ALL PARTS IN PLACE. FAILURE TO FOLLOW THIS INSTRUCTION MAY CAUSE THE BOLTS TO BE MISALIGNED DURING THE ASSEMBLY.

Hardware	QTY	Hardware	QTY	Hardware	QTY
① 	1	A  8x80mm	6	F 	4
② 	1	B  8x45mm	8	G 	8
③ 	2	C 	16	H 	4
④ 	2	D 	16	I 	1
		E 	10		

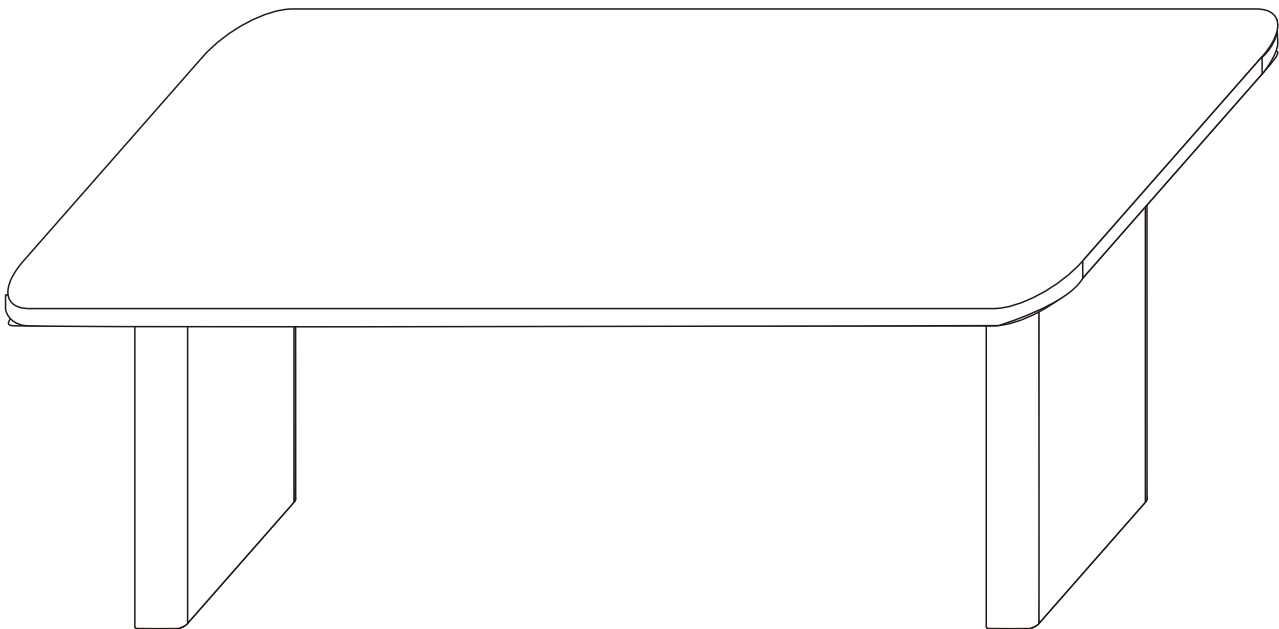

ASSEMBLY TIPS: Remove hardware from box and sort by size. Check that all hardware and parts are present before assembling. Following the instruction below in proper sequence to ensure fast, easy and correct assembly.



WARNING: DO NOT FULLY TIGHTEN ALL BOLTS UNTIL ALL PARTS IN PLACE. FAILURE TO FOLLOW THIS INSTRUCTION MAY CAUSE THE BOLTS TO BE MISALIGNED DURING THE ASSEMBLY.

Step 1

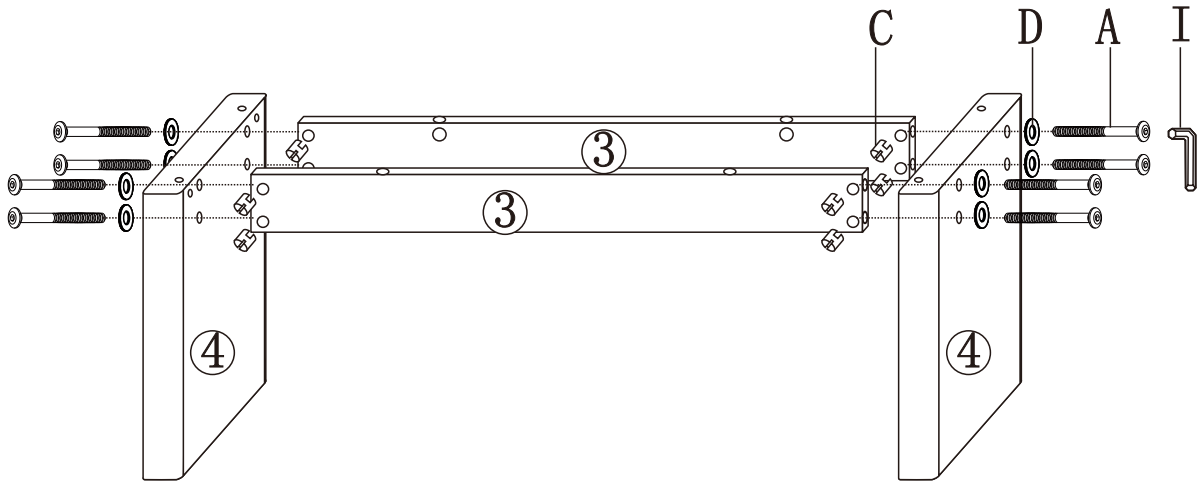

Step 2

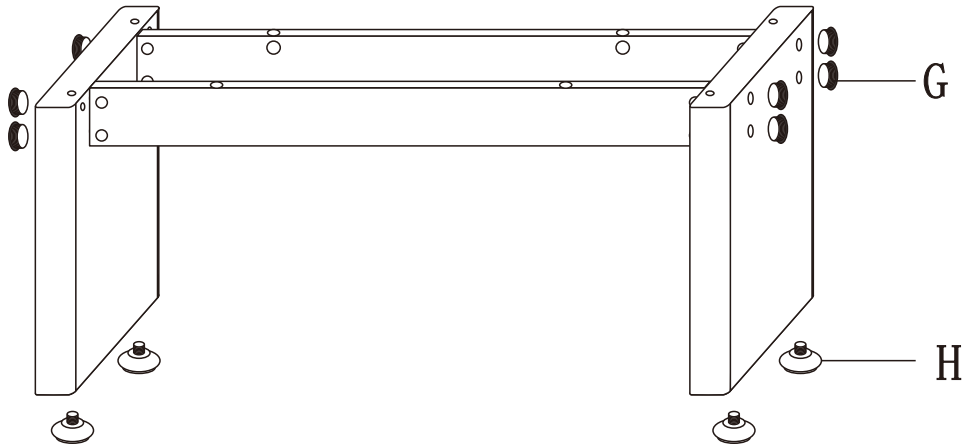

Step 3

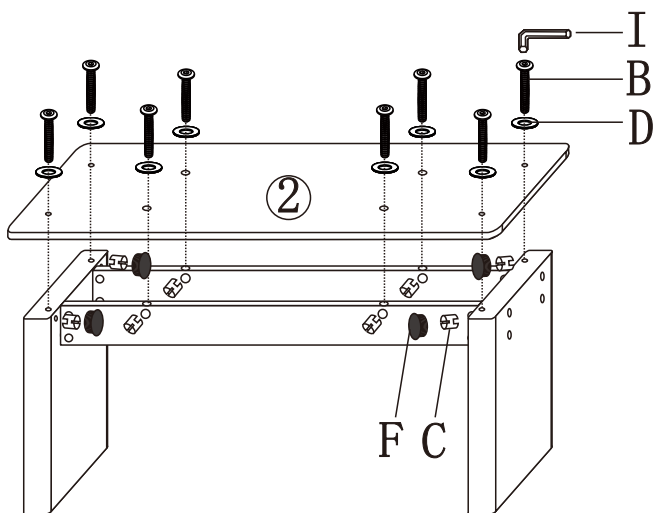

Step 4

