

ASSEMBLY INSTRUCTIONS

MOOK 5-Drawer Tallyboy







826-008



IMPORTANT

PLEASE READ BEFORE YOU CONTINUE FURTHER

1. MATERIAL USE LAMINATED PARTICLE BOARD, TO CLEAN USE SOFT, DRY CLOTH.
2. DO NOT USE DETERGENT OR CHEMICAL AVOID CONTACT WITH WATER AND DIRECT SUNLIGHT.
3. TO BE ASSEMBLED ON A SOFT, DRY, CLEAN SMOOTH SURFACE.
4. DO NOT USE ANY TOOLS OTHER THAN THOSE SHOWN.
5. USE OF POWER TOOLS TO ASSEMBLE THIS PRODUCT WILL INVALIDATE ANY CLAIM AND MAY DAMAGE THIS PRODUCT MAKING IT UNSAFE.
6. BEFORE STARTING ASSEMBLY PLEASE VERIFY IF ALL PARTS AND HARDWARE ARE INCLUDED.

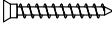
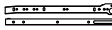
HARDWARE LIST			QTY (pcs)
DW4		Wood Dowel 6 x 25mm	62
LG1		Leg Pin	4
MF2		Nail	50 (+-3)
MN2		Mini Fix 15mm	14 Sets
PF2		Single Plastic Cap	20
SC3		Screw M3.5mm x 14mm	86
SC18		Screw M4mm x 38mm	20
SC25		FH Screw M5 x 40mm	14
SL7		Drawer Metal Slide 350mm	5 Sets

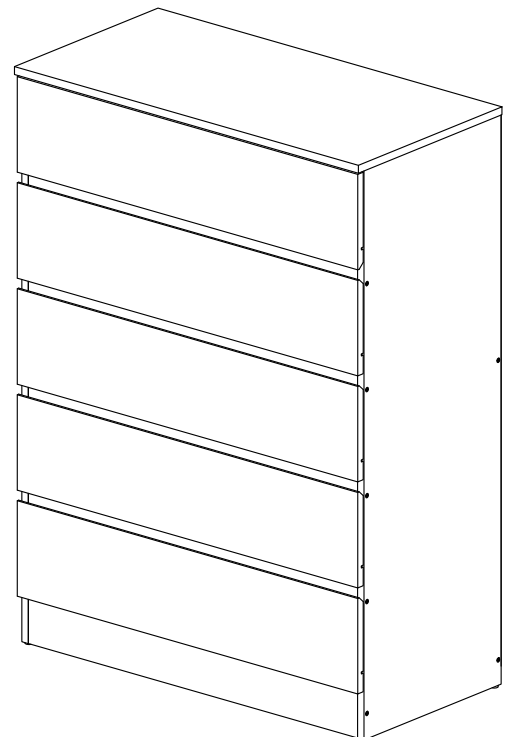

Parts List		QTY
A	Side Panel (L)	1 pc
B	Side Panel (R)	1 pc
C	Drawer Front Panel (A)	1 pc
D	Drawer Front Panel (B)	4 pcs
E	Drawer Side Panel (L)	5 pcs
F	Drawer Side Panel (R)	5 pcs
G	Top Panel	1 pc
H	Bottom Crossbar	2 pcs
I	Small Crossbar	5 pcs
J	Drawer Back Board	5 pcs
K	Drawer Crossbar	5 pcs
L	Drawer Bottom Panel	5 pcs
M	Backboard	2 pcs

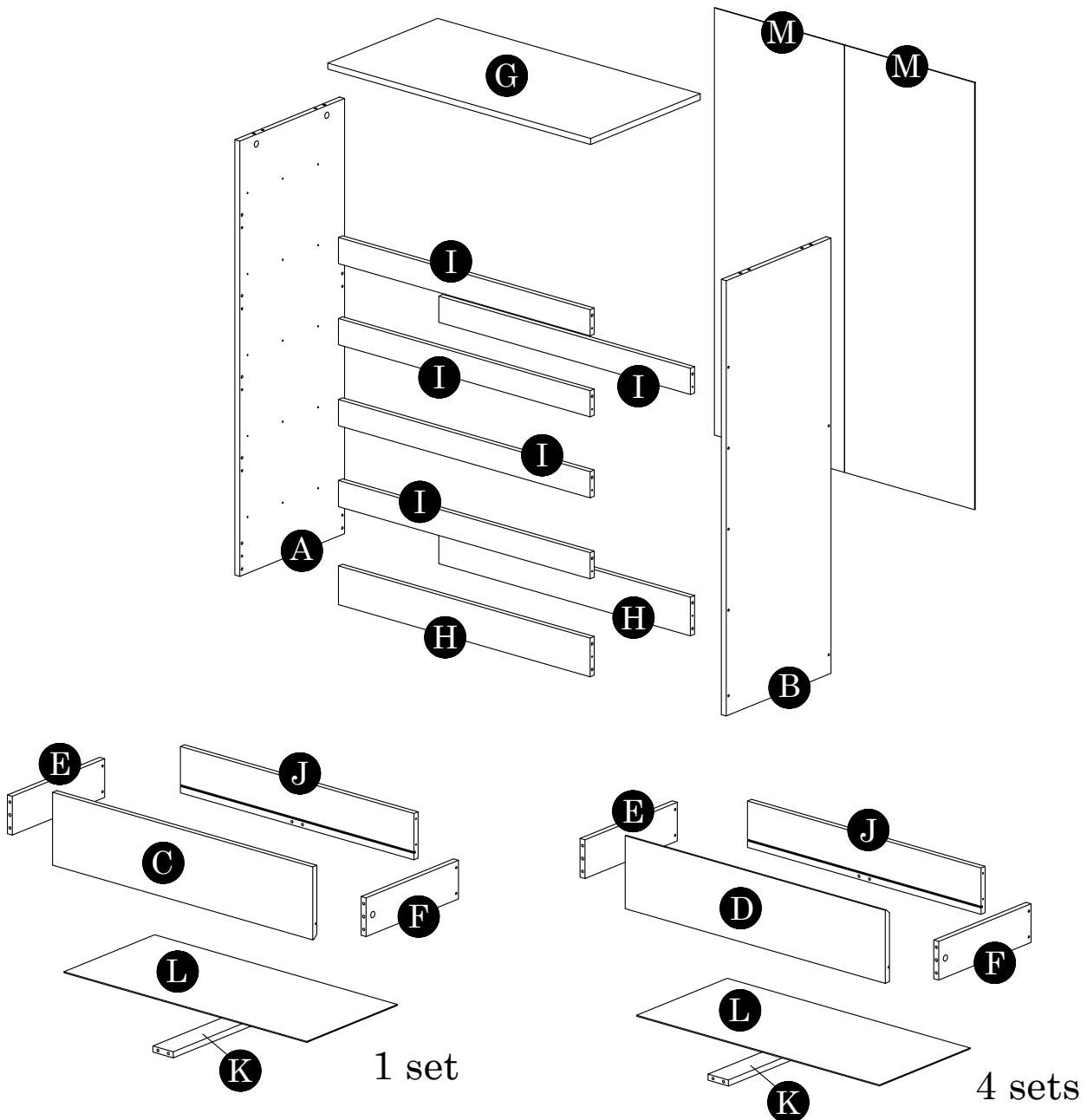

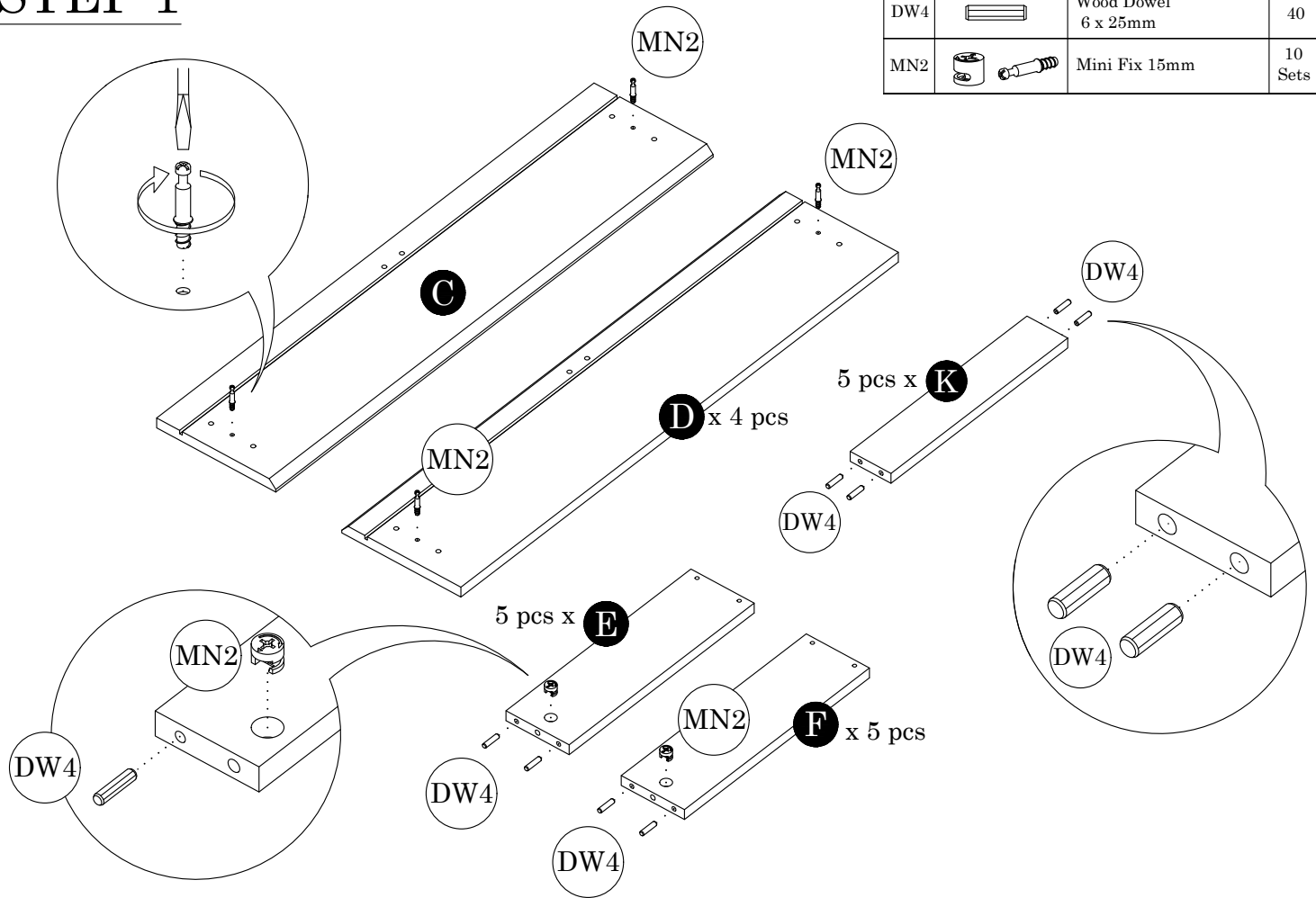

STEP 1

DW4		Wood Dowel 6 x 25mm	40
MN2		Mini Fix 15mm	10 Sets



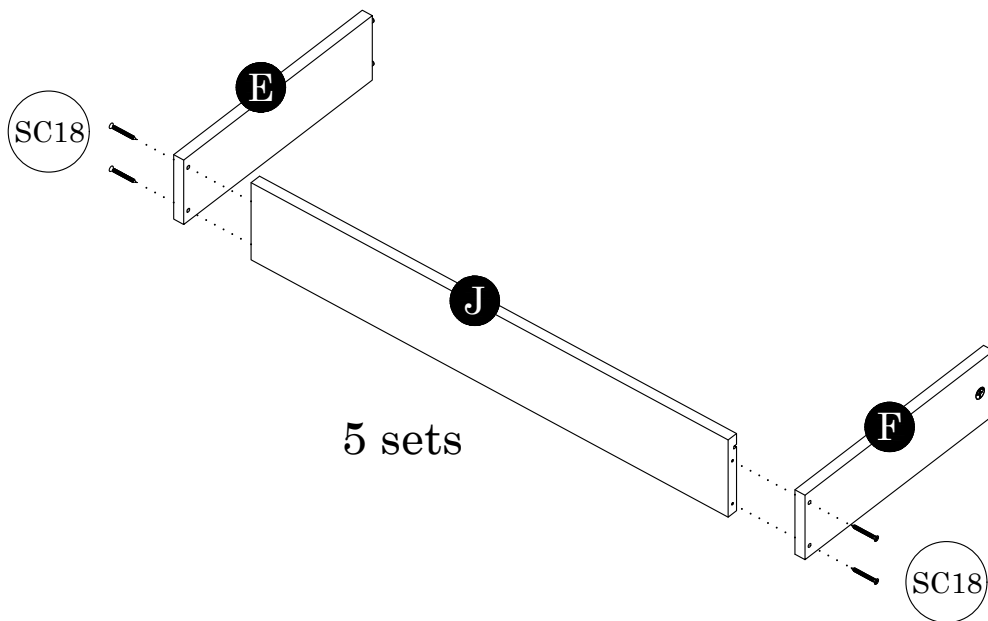

STEP 2





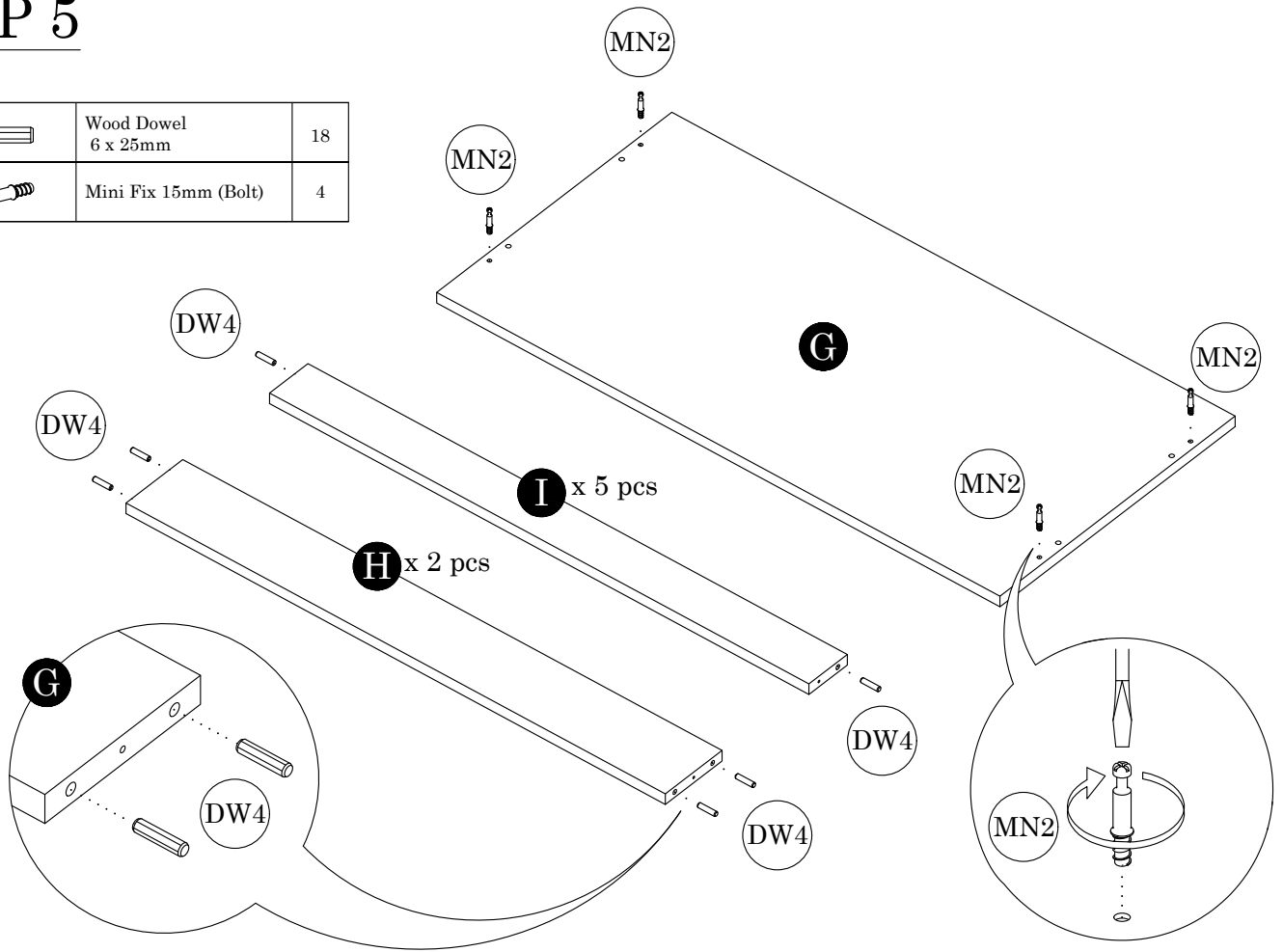

SC18		Screw M4 x 38mm	20
------	---	--------------------	----

STEP 5

DW4		Wood Dowel 6 x 25mm	18
MN2		Mini Fix 15mm (Bolt)	4



STEP 6

DW4		Wood Dowel 6 x 25mm	4
MN2		Mini Fix 15mm (Cam)	4
SC3		Screw M3.5mm x 14mm	30
SL7		Drawer Metal Slide 350mm	5 Sets

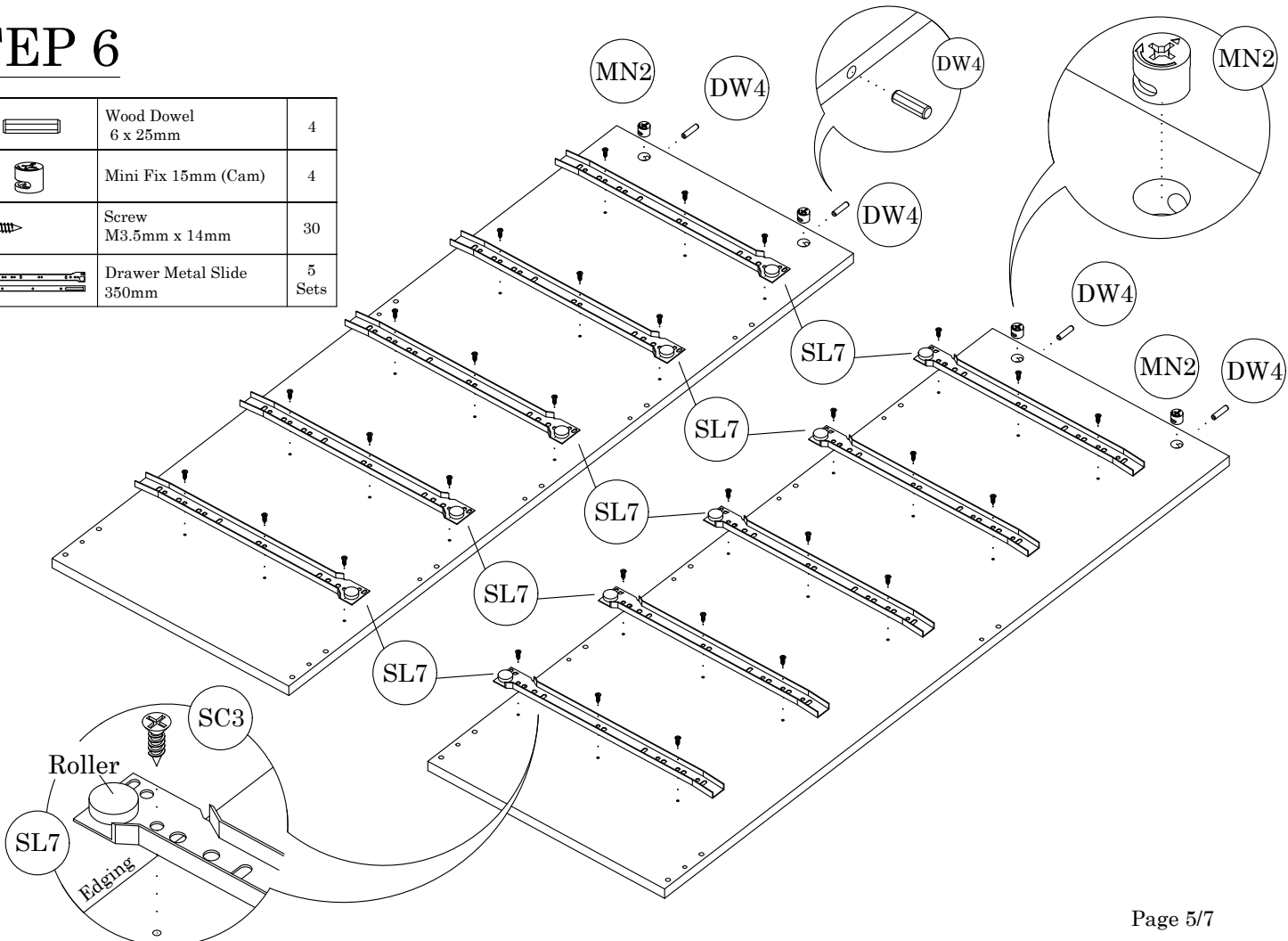

STEP 7

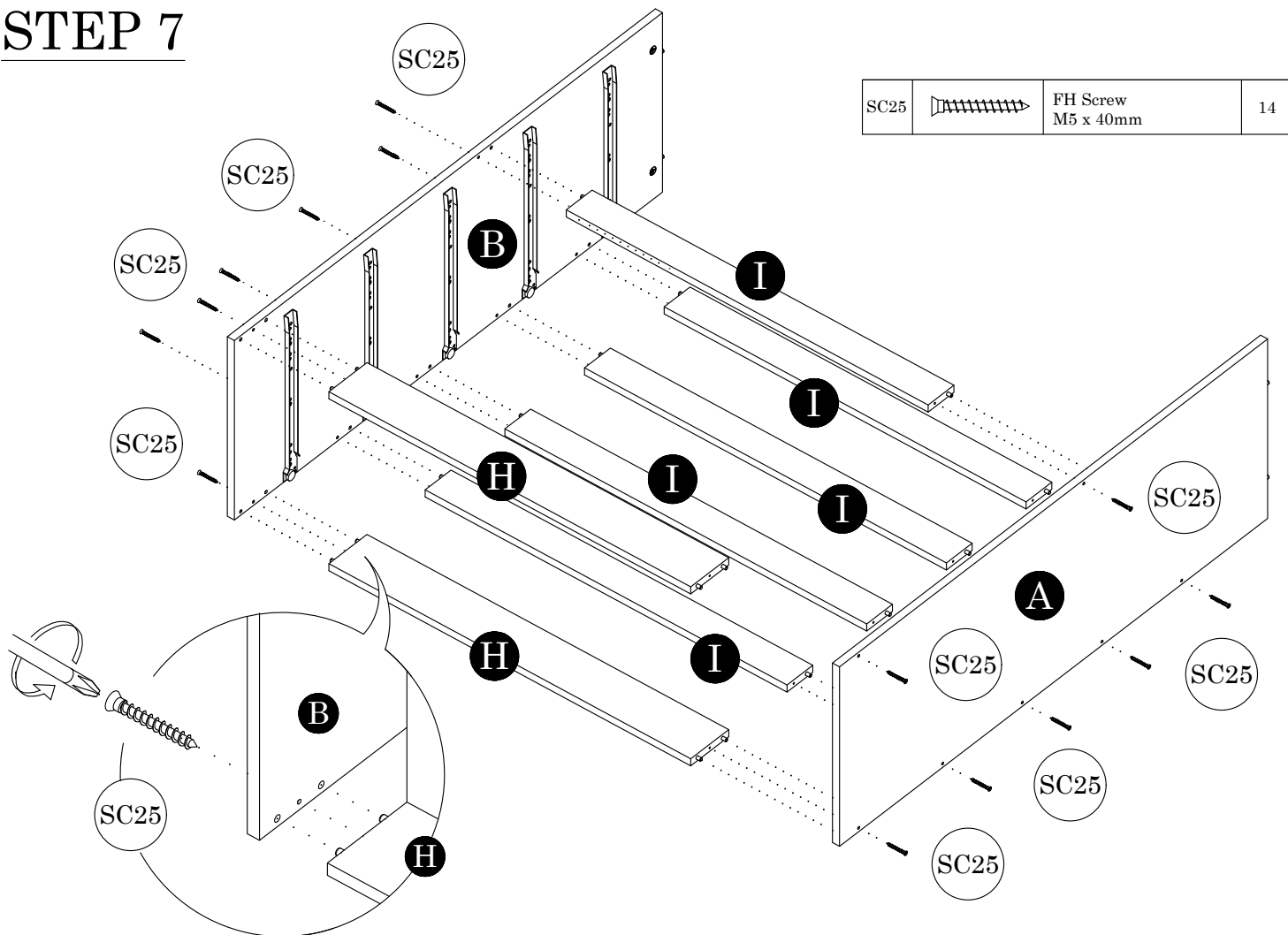

STEP 8

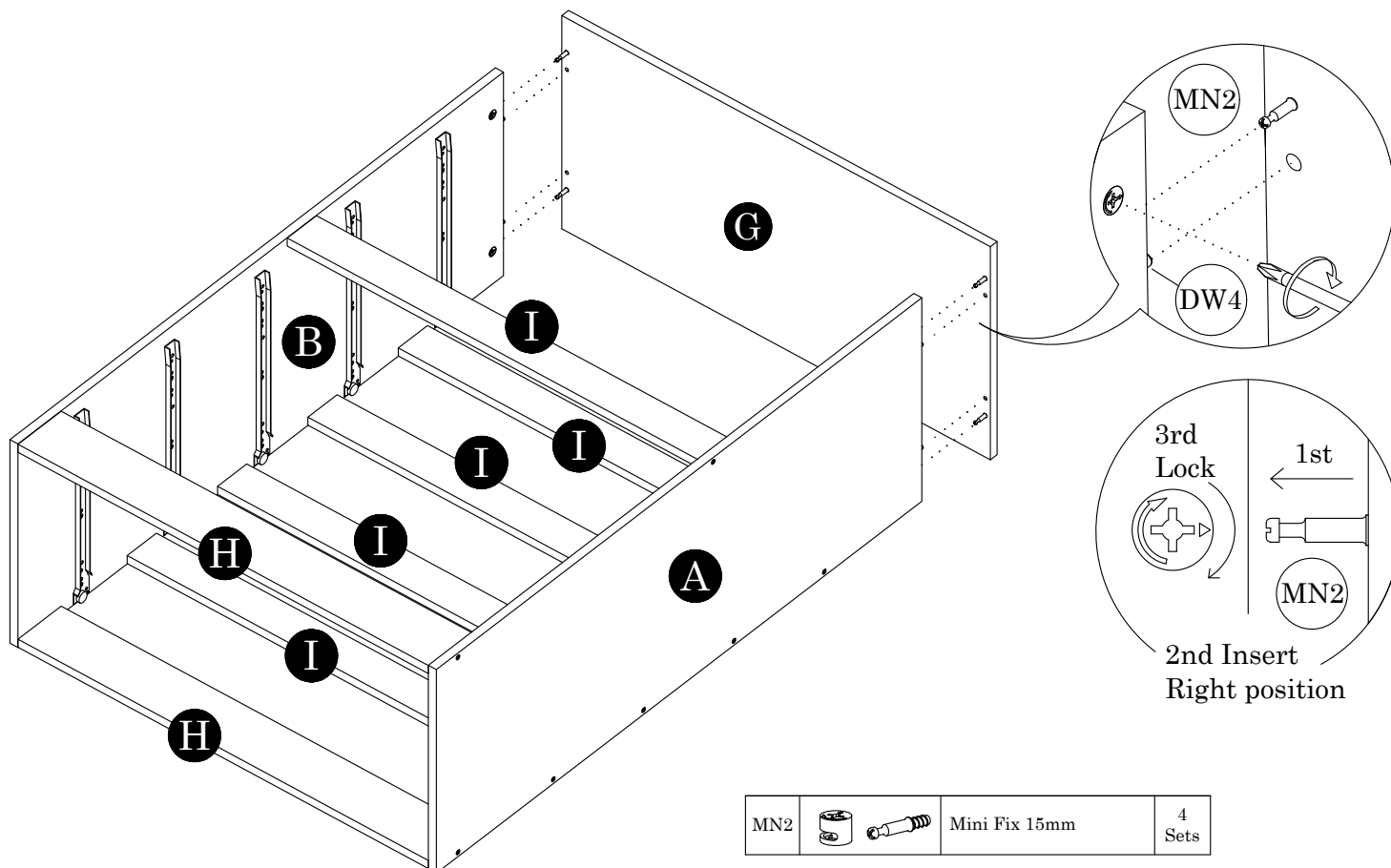

STEP 9

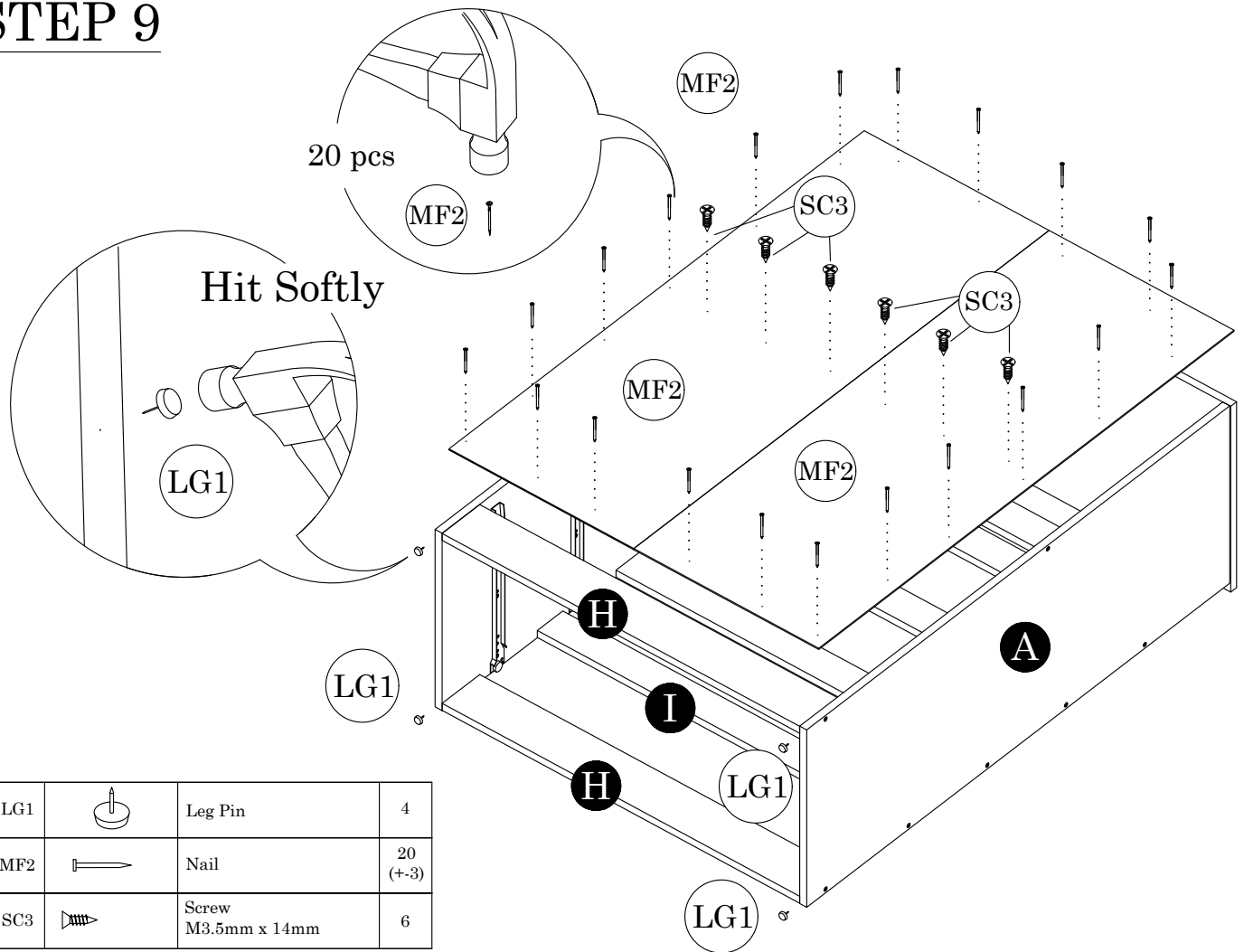

STEP 10

