











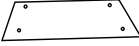

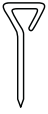

Ax1 	Bx4 	Cx1 	Dx8 	Ex12 	Fx1 
Gx8 	Hx8 	Ix4 	Jx1 	Kx4 	Lx4 
Mx4 	Nx8 	Ox2 	Px4 	Qx4 	 x2

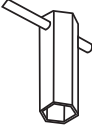
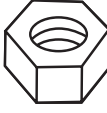
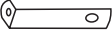
1



2

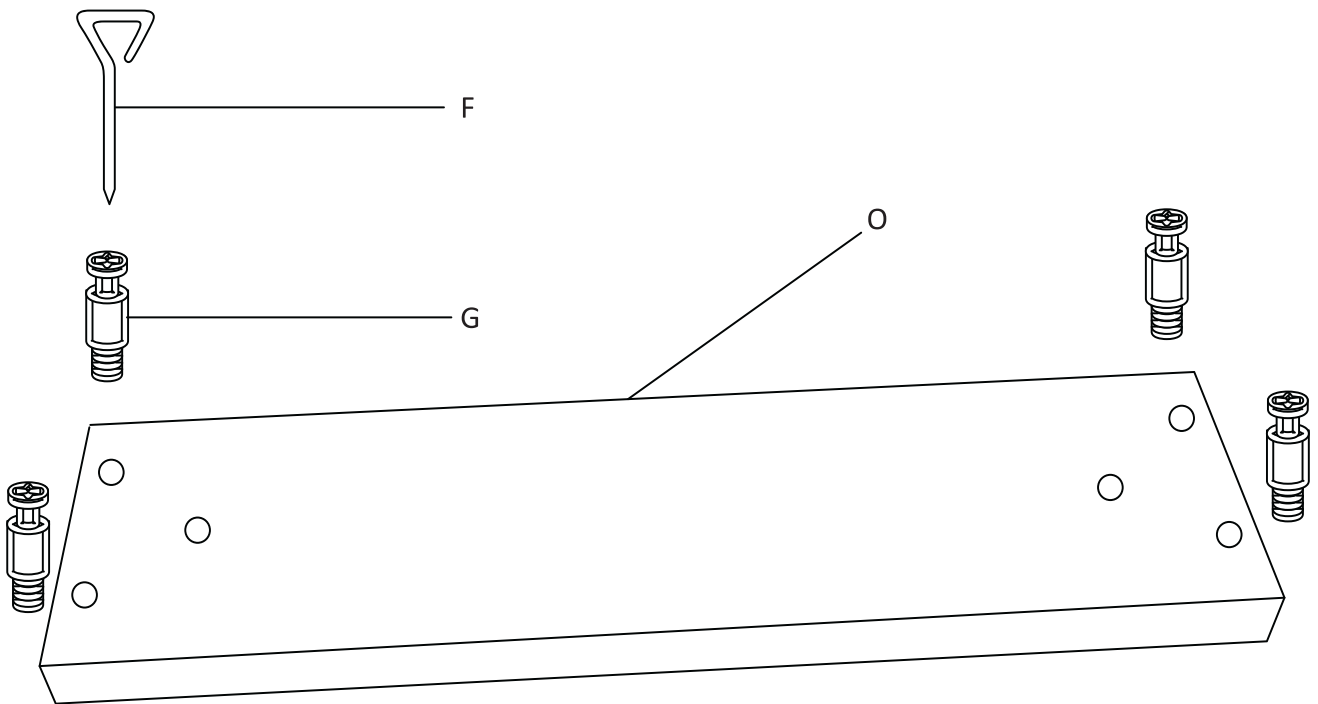
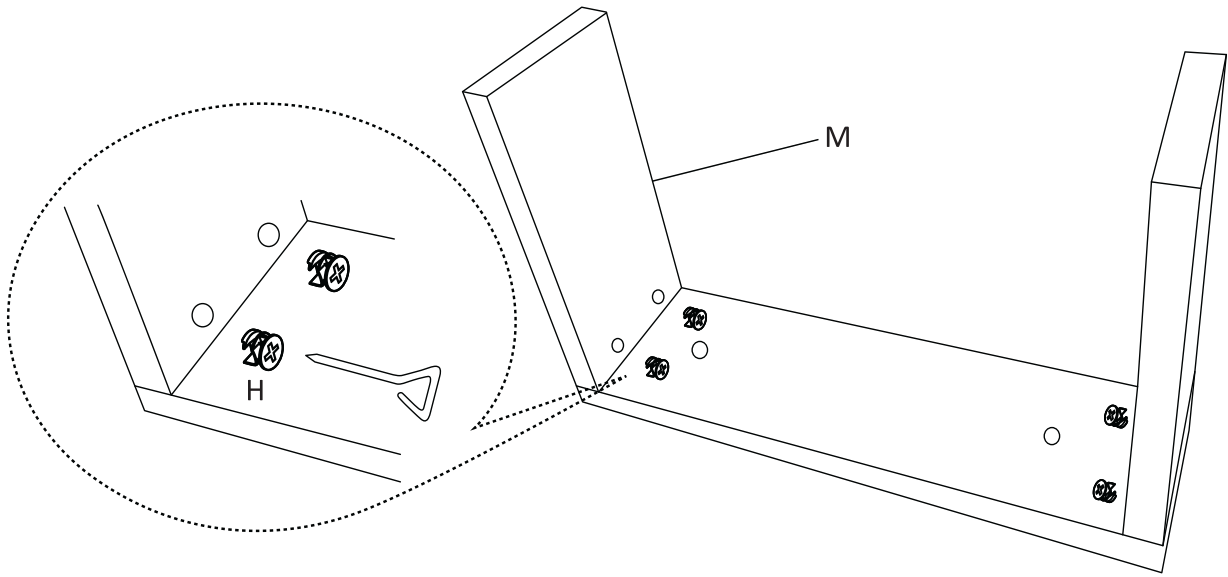

3

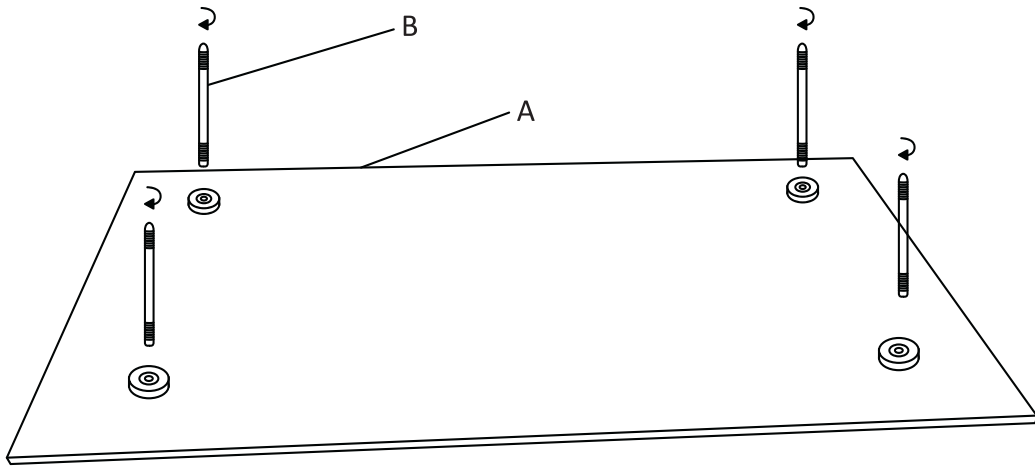

4

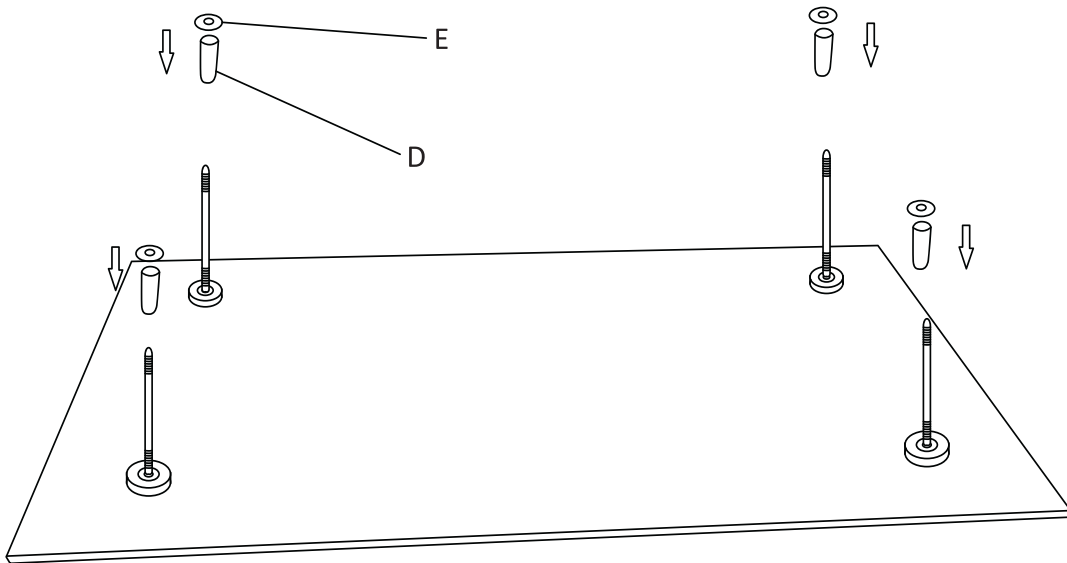

5

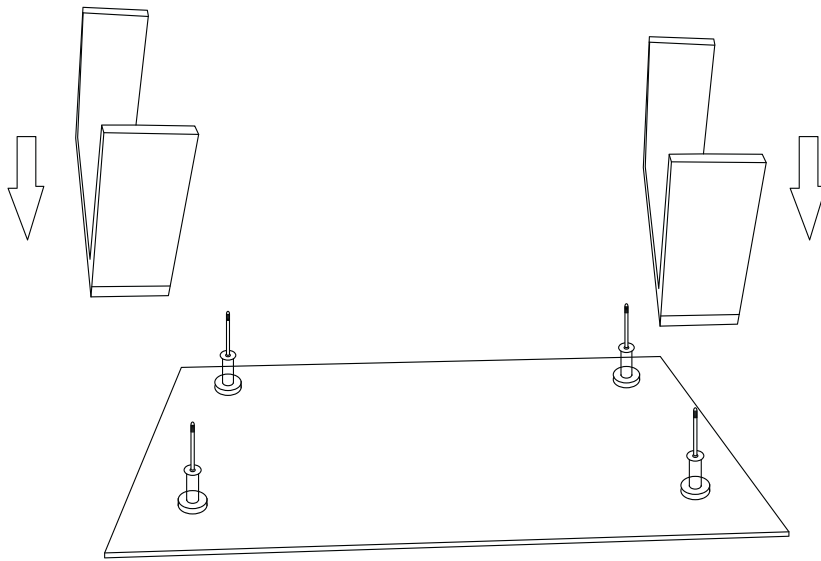

6

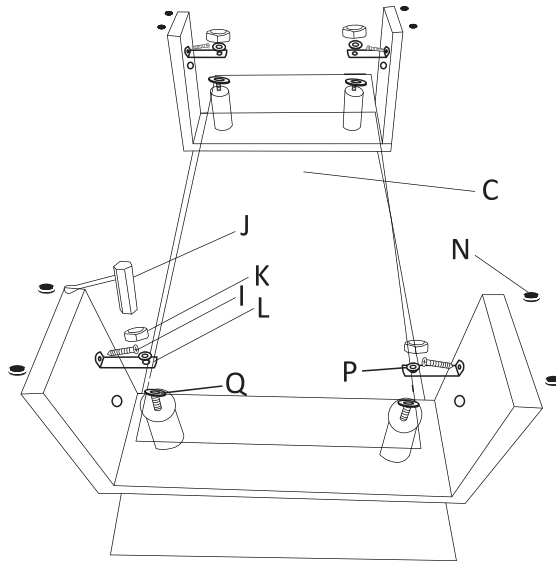

7

