

Assembly drawing

1

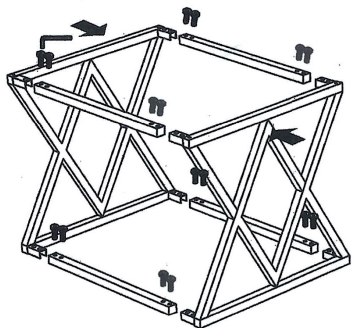

X16



X1

2

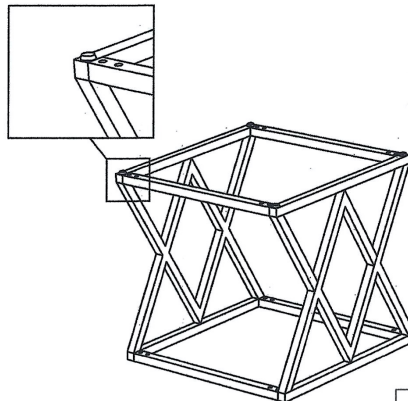

X4

3

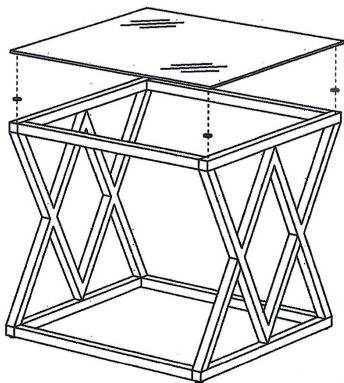

X4

4

