

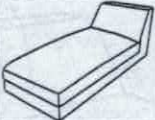





ASSEMBLY INSTRUCTION

SKU#:124290489

PARTS LIST					HARDWARE LIST			
	NO.	DESCRIPTION	SKETCH	Q'TY	NO.	DESCRIPTION	SKETCH	Q'TY
	A	Sofa Body		1pc	1	Bolt 5/16*1"		16+2pcs Extra
	B	Back Cushion		1pc	2	Spring Washer 5/16"		16+2pcs Extra
	C	Leg		4pcs	3	Flat Washer 5/16"		16+2pcs Extra
					4	Allen Key		1pc



WARNING

- Read all instructions carefully and completely before assembly and use. Retain for future reference.
- Keep plastic bags and small parts away from children.
- DO NOT use power tools.
- DO NOT overtighten hardware.
- Periodically check hardware and re-tighten as necessary.
- DO NOT use product if any component becomes damaged.
- For residential(non-commercial)use only.
- Max Weight Limit=500lb.
- DO NOT stand on product. Use only for intended purpose.

Step 1:

Attach the Legs (C) to Sofa Body (A) using Bolts (1), Spring Washers (2), and Flat Washers (3).
Find the Red arrows on the Leg(C) and the base of the Sofa Body(A),
Install four Legs(C) in the direction indicated by the arrows.

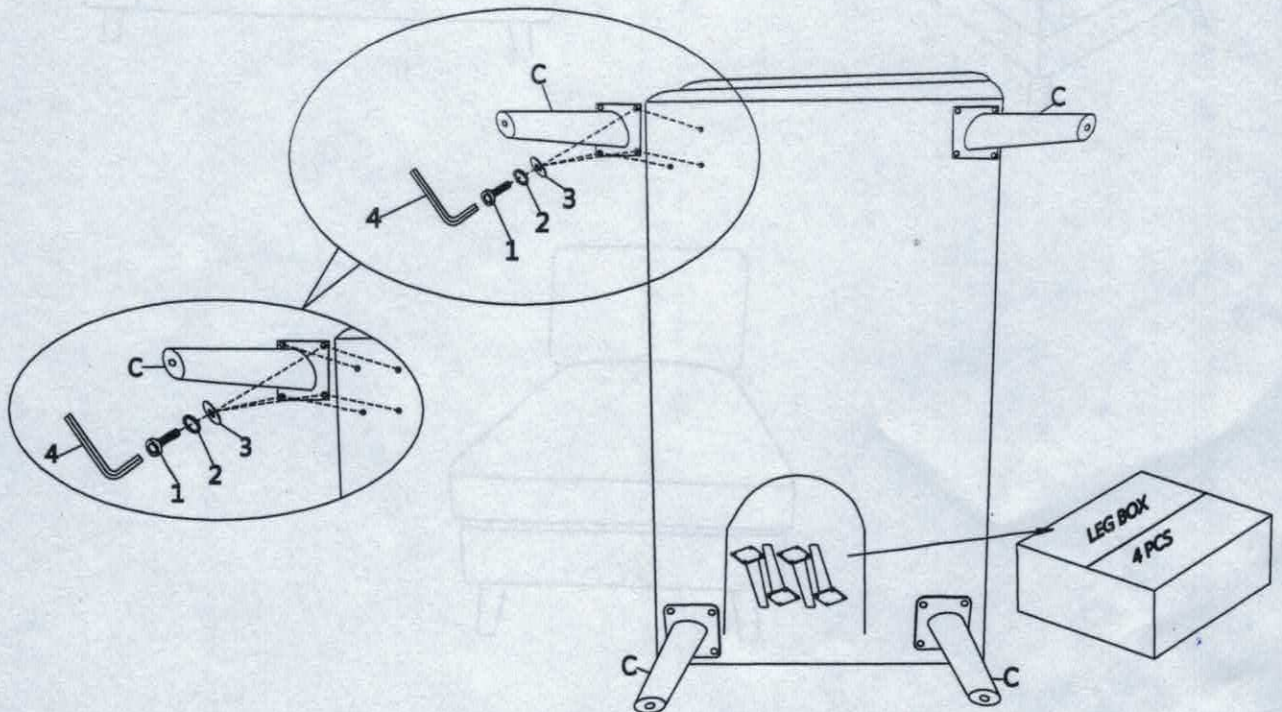

Step 2:

Place the Back Cushion (B) on Sofa Body (A).

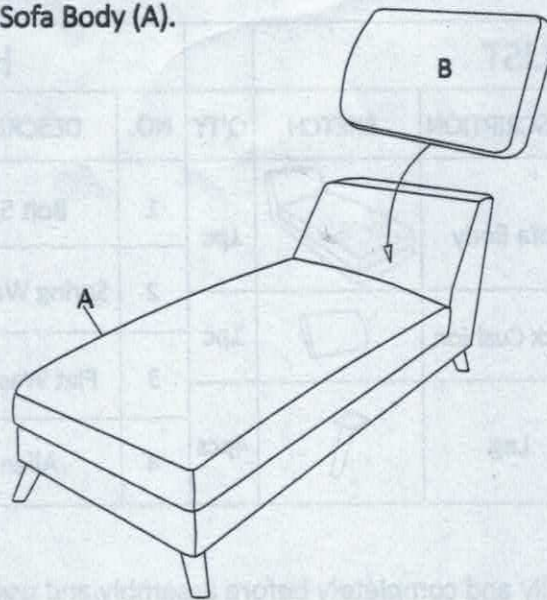

Assembly is completed.

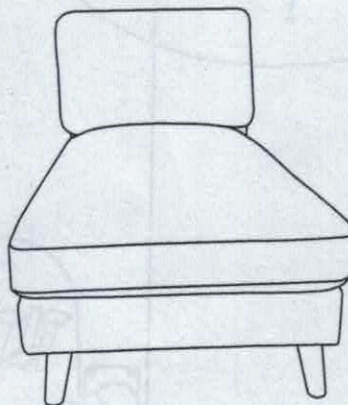
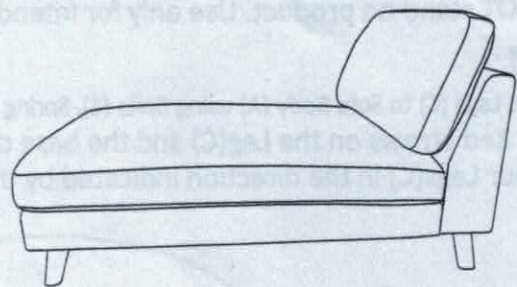
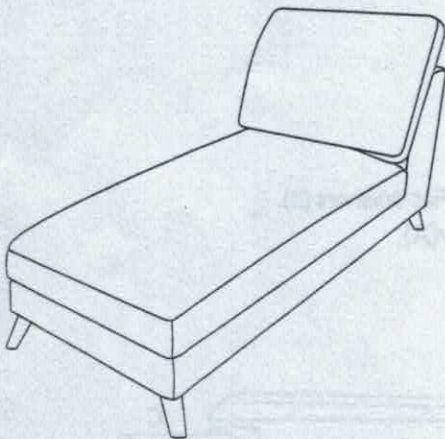







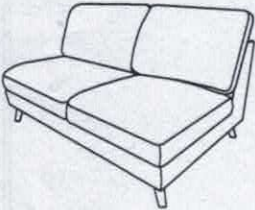

ASSEMBLY INSTRUCTION

SKU#124210548

PARTS LIST

HARDWARE LIST

	NO.	DESCRIPTION	SKETCH	Q'TY	NO.	DESCRIPTION	SKETCH	Q'TY
	A	Sofa Body		1pc	1	Bolt 5/16*1"		16+2pcs Extra
	B	Back Cushion		2pcs	2	Spring Washer 5/16"		16+2pcs Extra
	C	Leg		4pcs	3	Flat Washer 5/16"		16+2pcs Extra
					4	Allen Key		1pc



WARNING

- Read all instructions carefully and completely before assembly and use. Retain for future reference.
- Keep plastic bags and small parts away from children.
- DO NOT use power tools.
- DO NOT overtighten hardware.
- Periodically check hardware and re-tighten as necessary.
- DO NOT use product if any component becomes damaged.
- For residential(non-commercial)use only.
- Max Weight Limit=500lb.
- DO NOT stand on product. Use only for intended purpose.

Step 1:

Attach the Legs (C) to Sofa Body (A) using Bolts (1), Spring Washers (2), and Flat Washers (3).
Find the Red arrows on the Leg(C) and the base of the Sofa Body(A),
Install four Legs(C) in the direction indicated by the arrows.

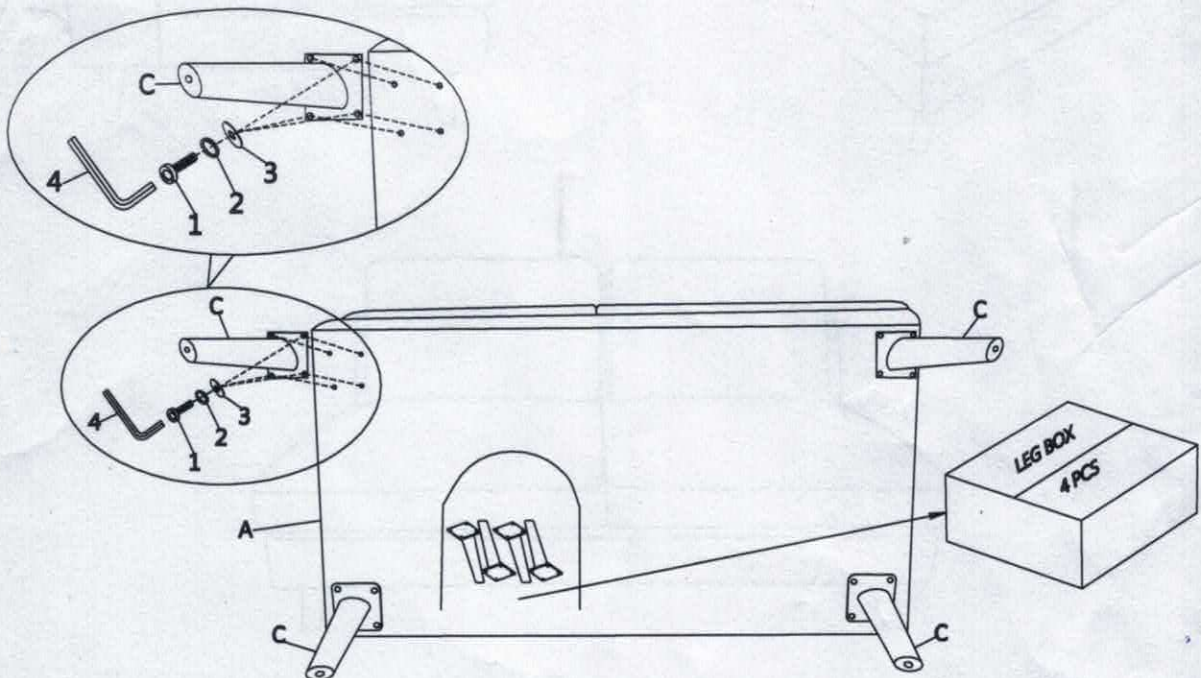

Step 2:

Place the Back Cushion (B) on Sofa Body (A).

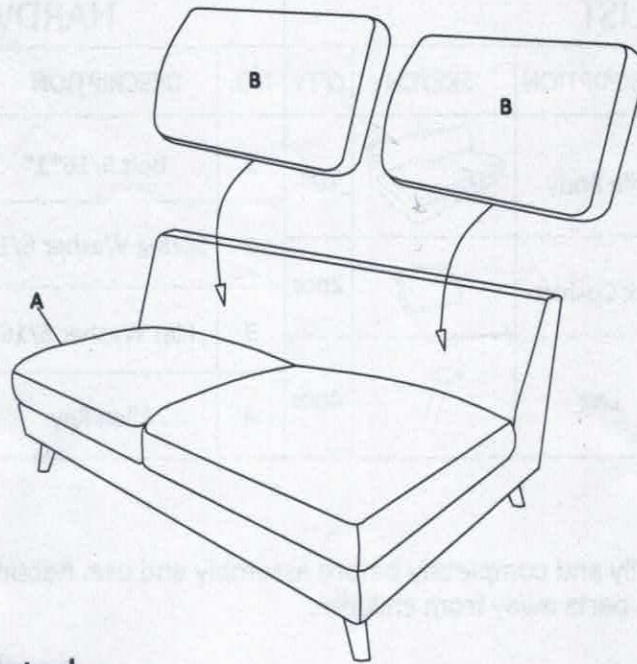

Assembly is completed.

