

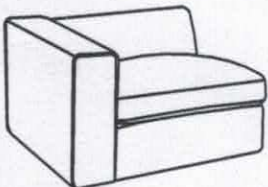

HS-3878E

<p>A*1</p> 	<p>B*1</p> 	<p>C*1</p> 	<p>D*1</p> 
<p>E*1</p> 	<p>F*1</p> 	<p>G*4</p> 	<p>H*24</p> 
<p>I*24</p> 	<p>J*1</p> 	<p>K*1</p> 	

STEP 1 :

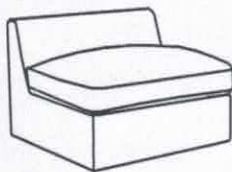
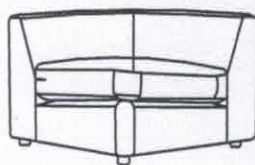
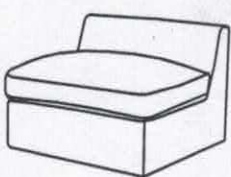
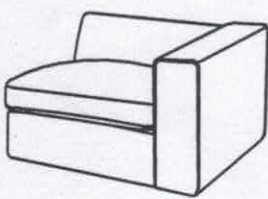
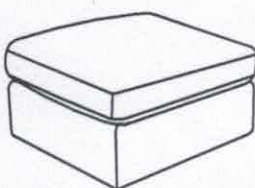
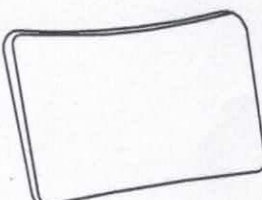

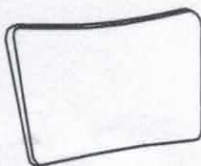
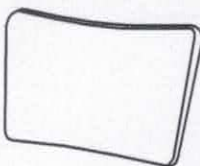
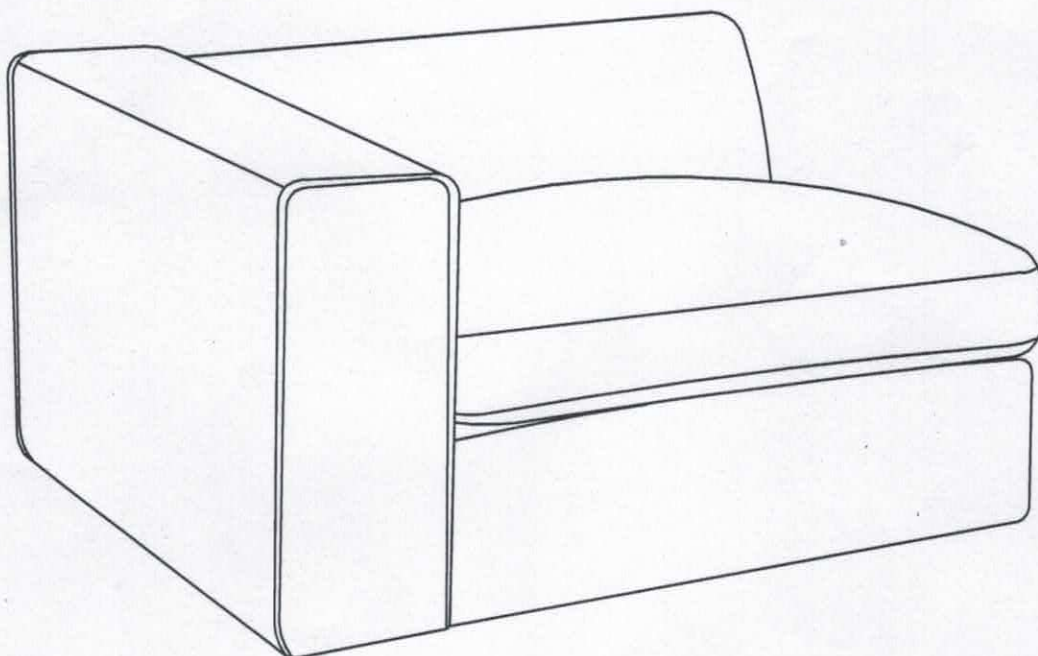
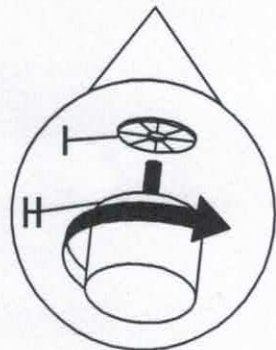
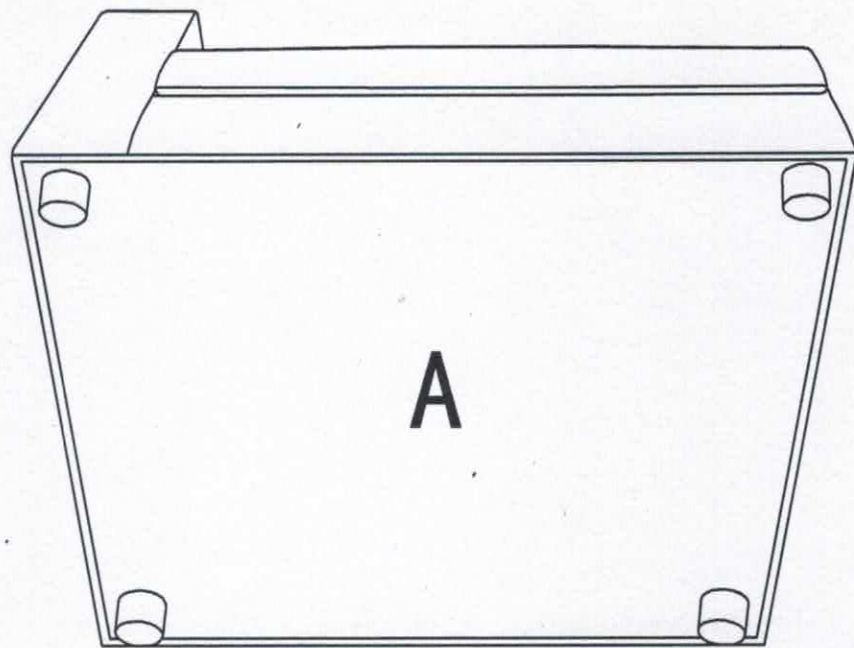
STEP 2:

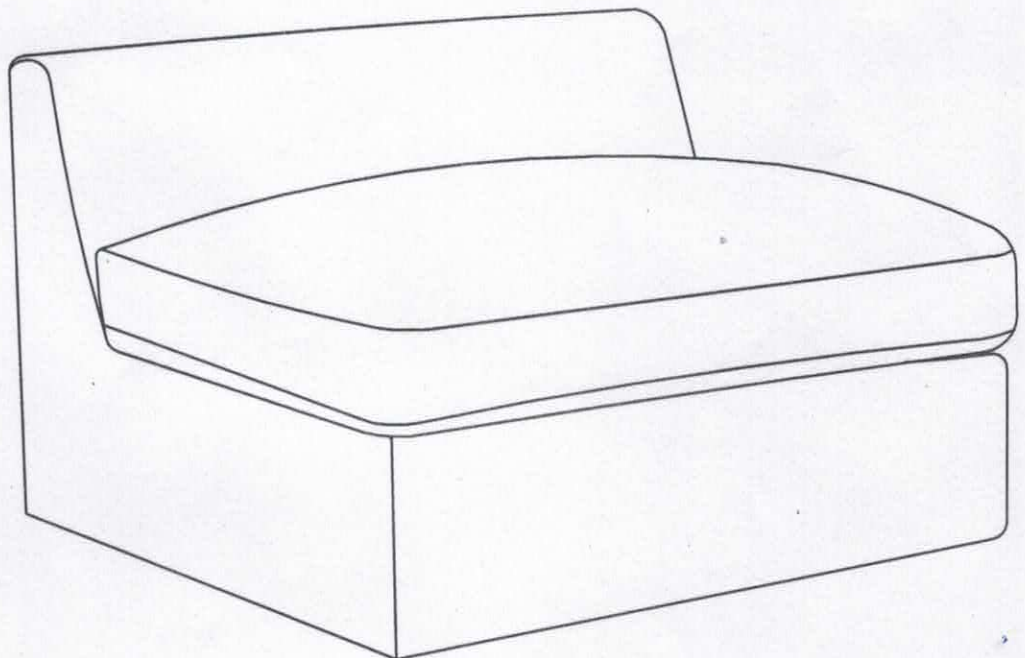
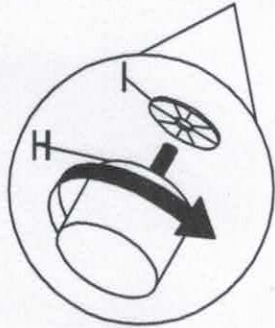
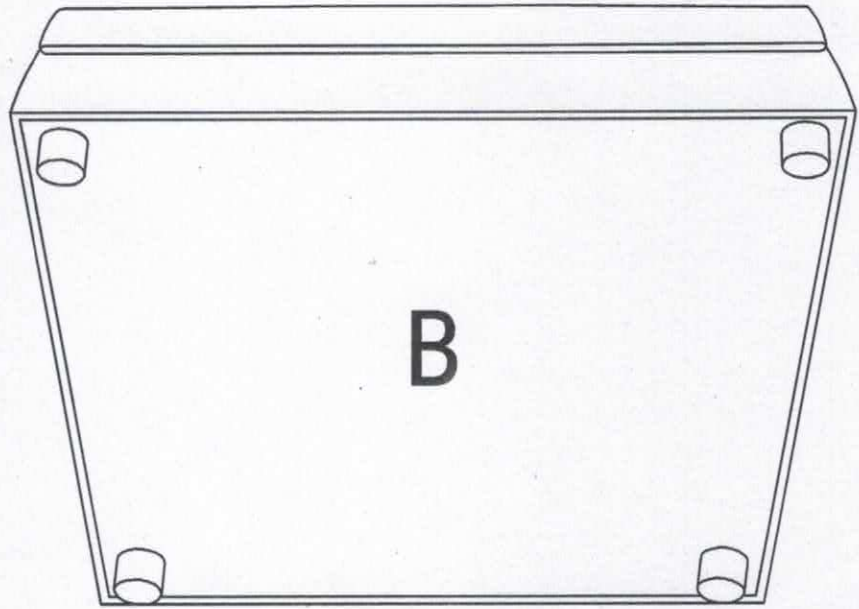

STEP 3:

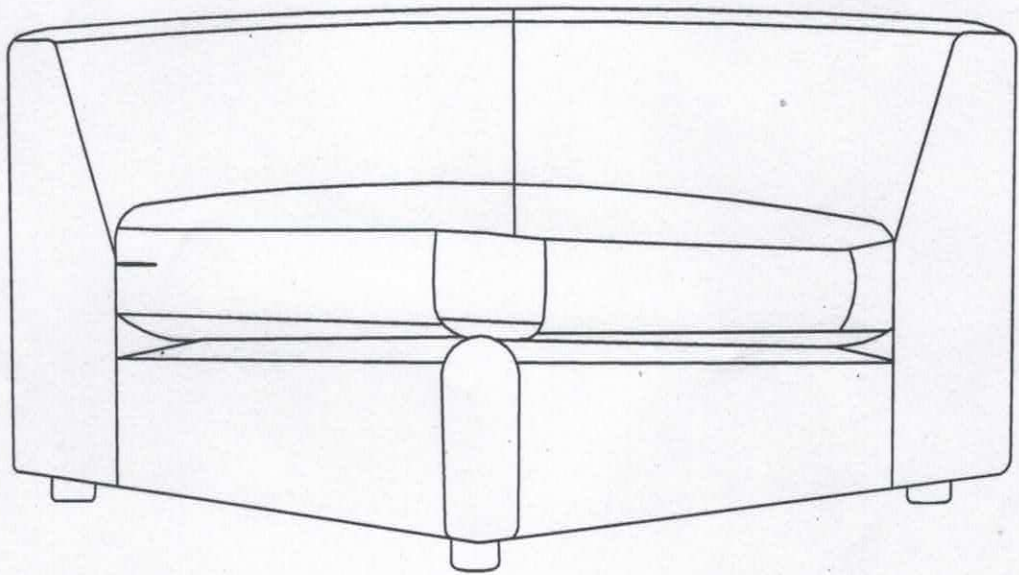
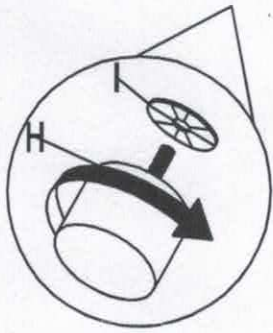
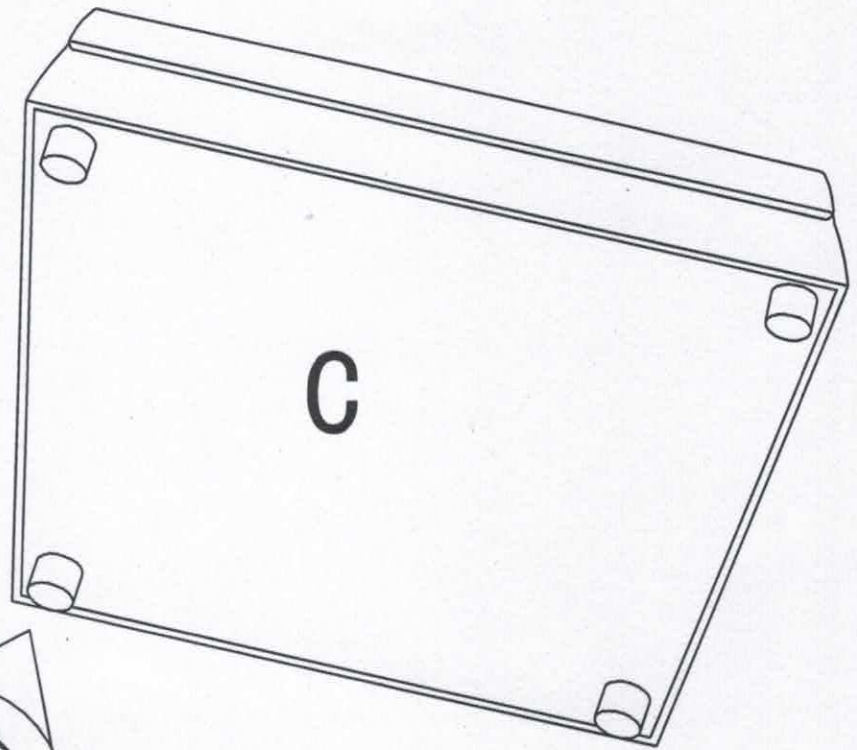

STEP 4:

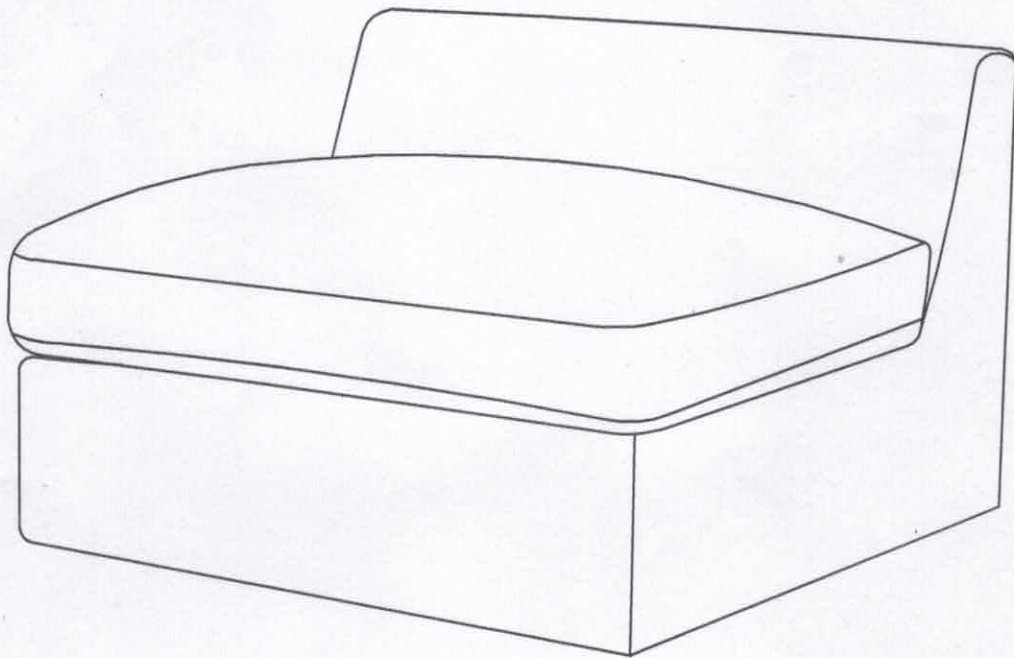
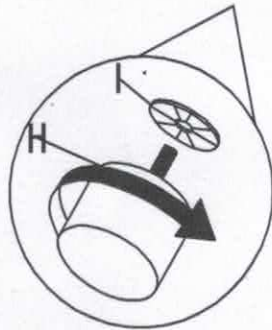
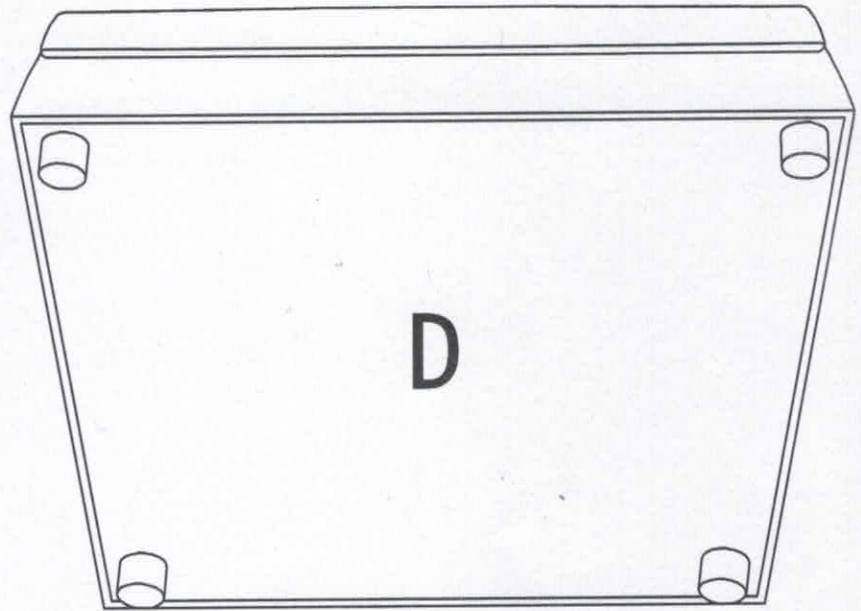

STEP 5:

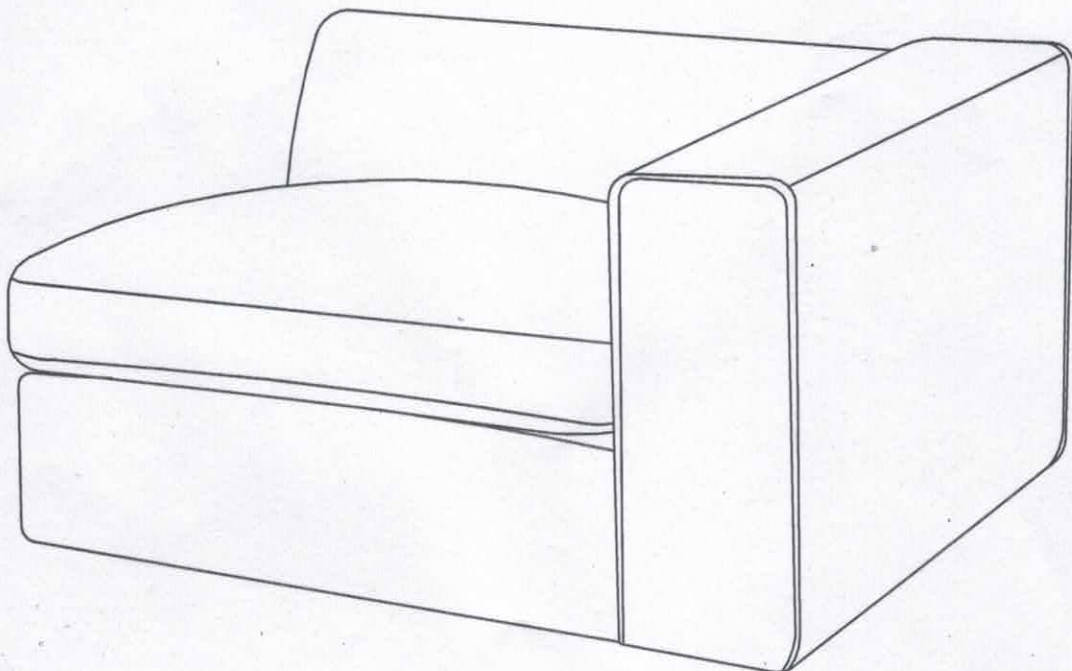
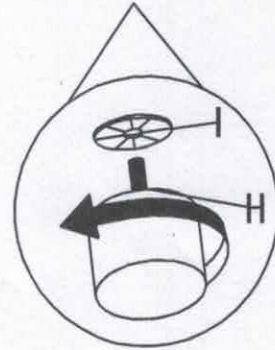
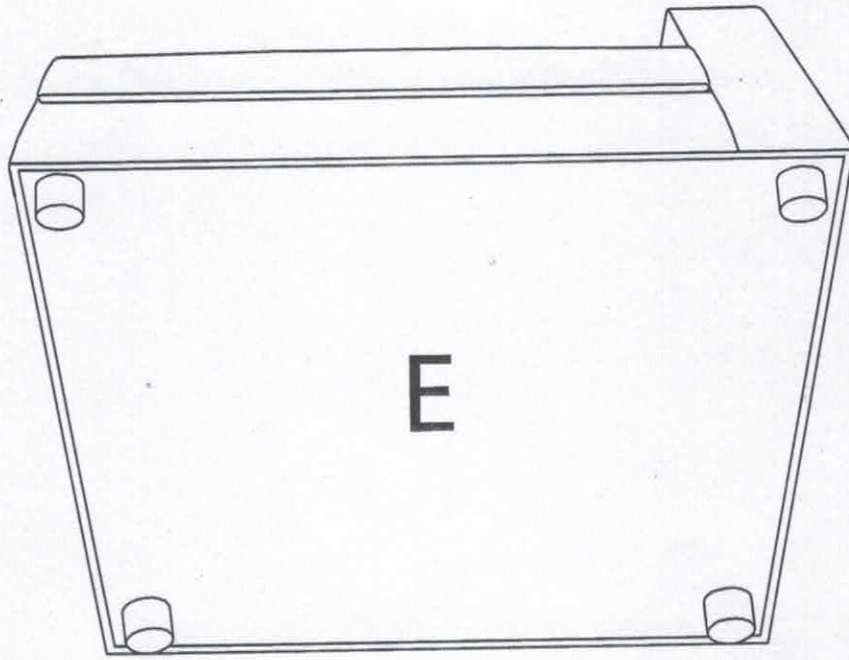

STEP 6:

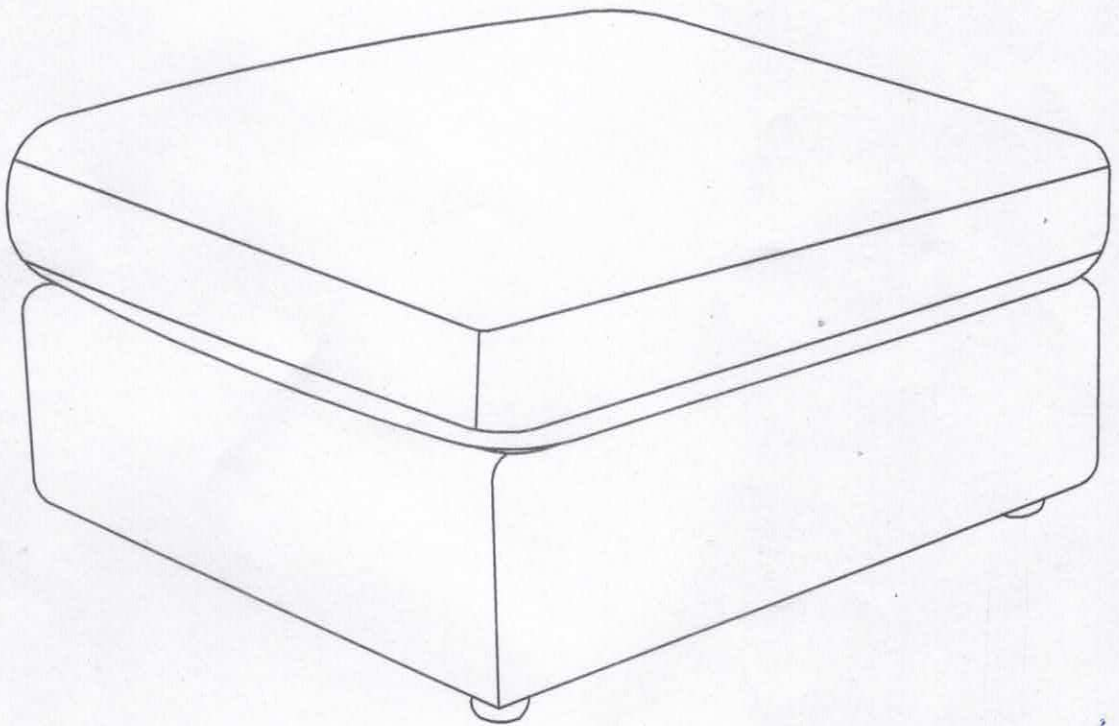
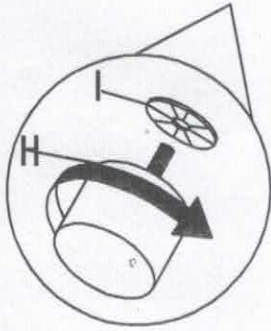
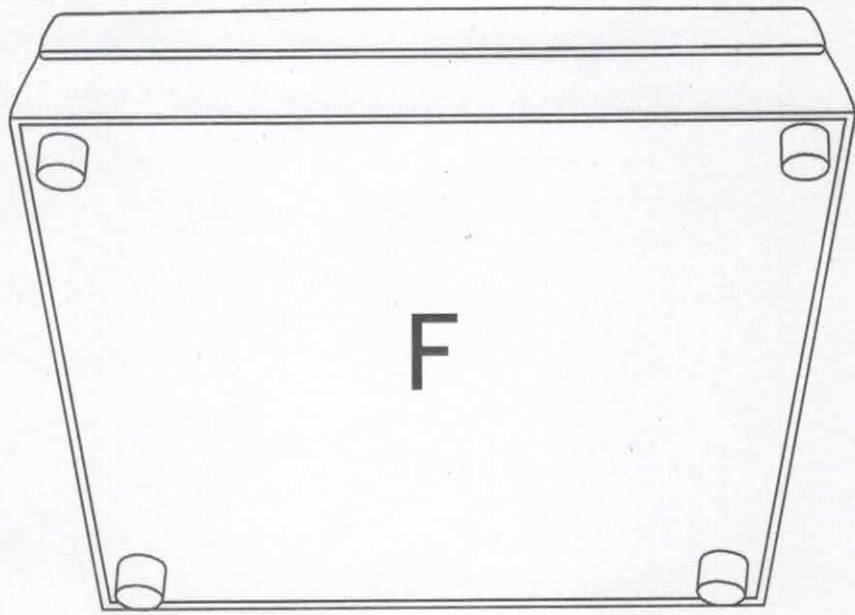

STEP7:

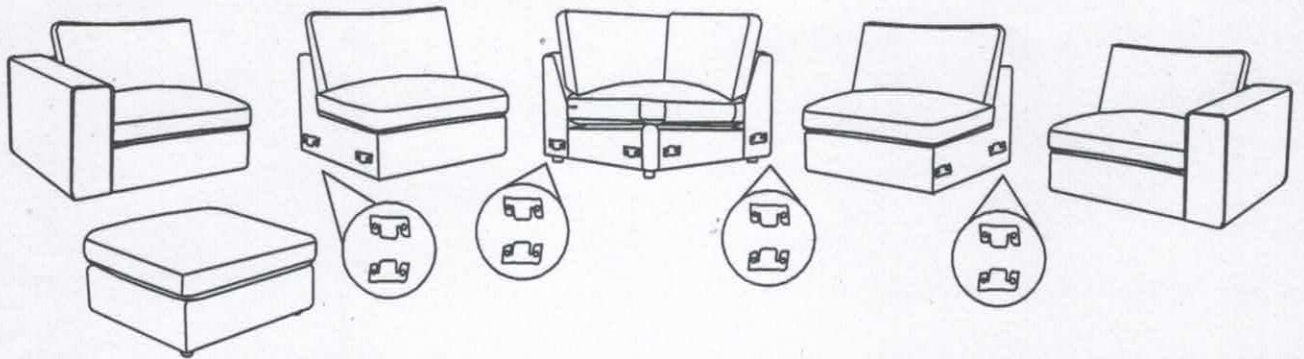

STEP8:

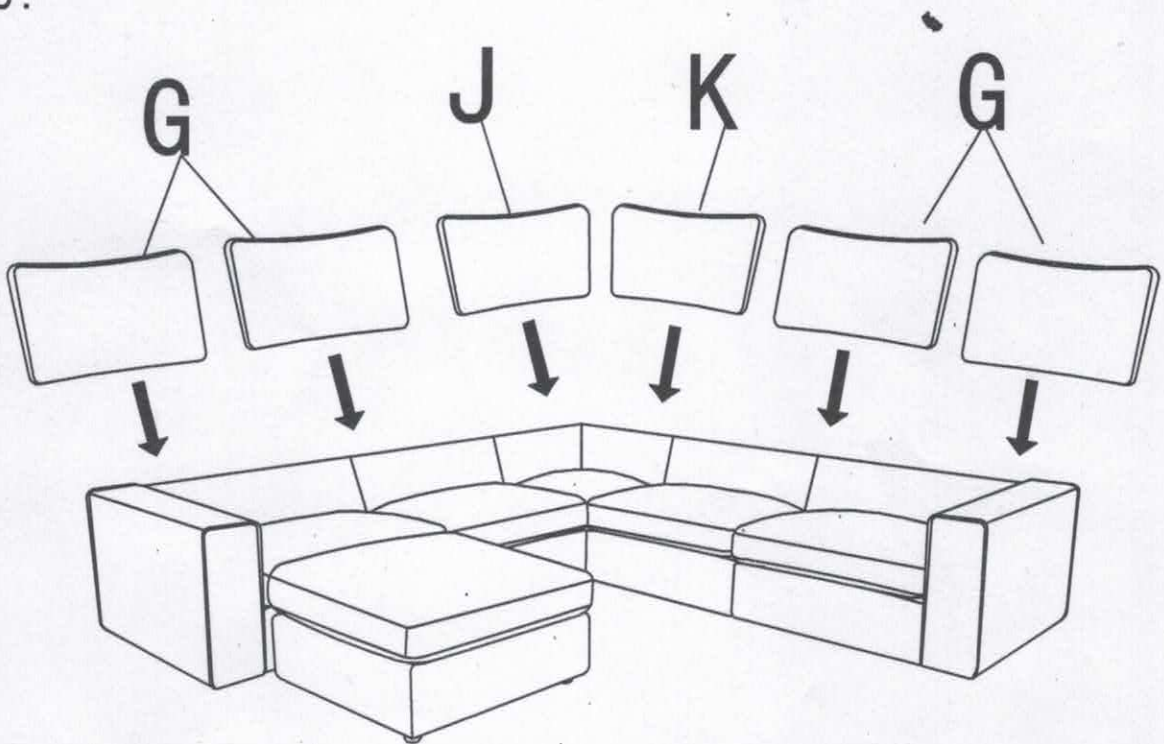

STEP9:

