

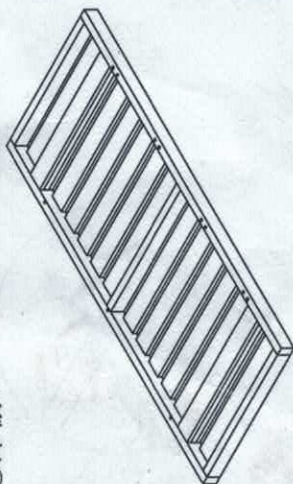

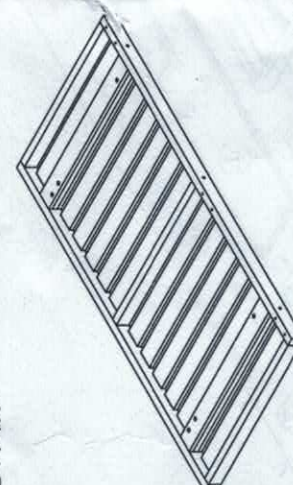

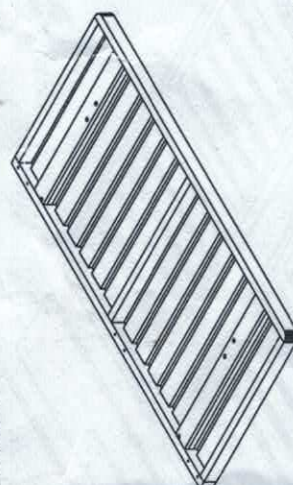

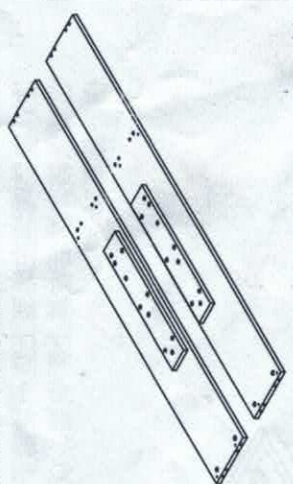

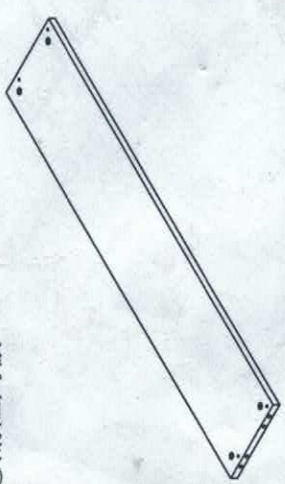



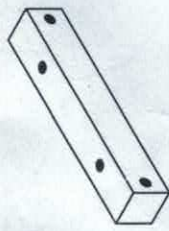

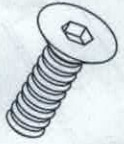
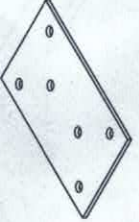

<p>①床板1</p>  <p>1X</p>	<p>②床板2</p>  <p>1X</p>	<p>③床板3</p>  <p>1X</p>	<p>④底框左右侧板</p>  <p>1X</p>	<p>⑤底框间板</p>  <p>1X</p>	<p>⑥底框前拉板</p>  <p>1X</p>	<p>⑦底框中拉板</p>  <p>1X</p>	<p>⑧底框后拉板</p>  <p>1X</p>	<p>⑨实木加方</p>  <p>6X</p>	<p>⑩底板</p>  <p>4X</p>	<p>A. 三合一杆</p>  <p>23+1X</p>	<p>B. 三合一扣</p>  <p>23+1X</p>	<p>C. 木肖</p>  <p>23X</p>	<p>G. 倒边内六角螺丝</p>  <p>8+1X</p>	<p>H. 铁片</p>  <p>3X</p>	<p>I. 垫片</p>  <p>8+1X</p>	<p>J. 灰毛毡(Φ16*3)</p>  <p>3X</p>	<p>K. 黑色软垫(Φ35)</p>  <p>20X</p>	<p>L. 纤维钉(4*20)</p>  <p>12+1X</p>	<p>M. 纤维钉(4*45)</p>  <p>24+1X</p>	<p>N. 两用螺丝刀</p>  <p>1X</p>	<p>O. 内六角扳手</p>  <p>1X</p>	<p>品牌: GF085-15B</p> <p>规格: 1500*2000*290H</p> <p>客服: 400-870-9808</p> <p>CON 志光</p>
--	--	---	--	--	---	--	--	---	---	--	---	---	---	--	--	---	--	--	--	---	--	--

步骤 1

注：安装时请在地面上垫一块毯子或本包装纸箱，然后在其上面安装，以免擦伤产品零部件！

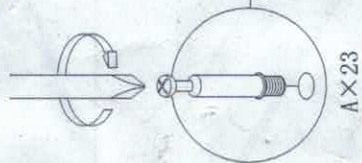
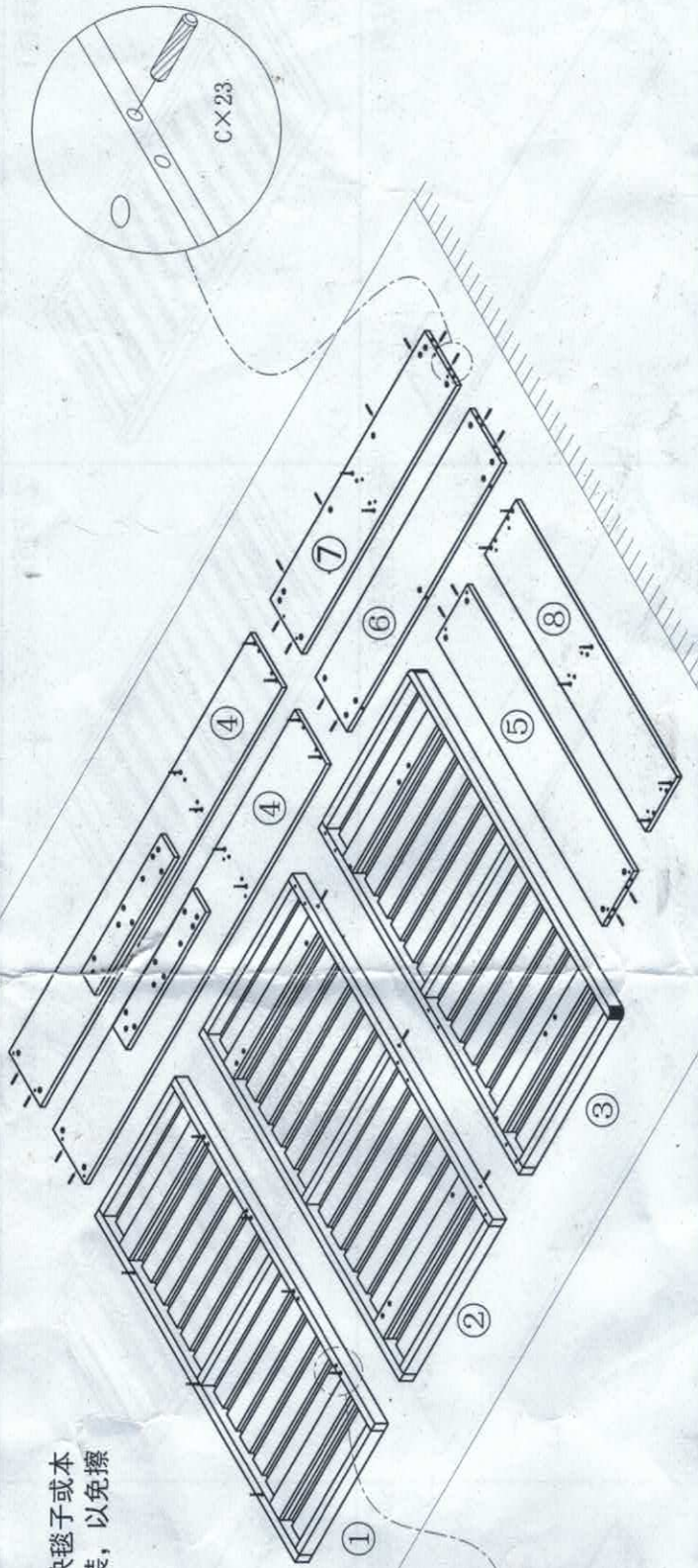

步骤 2

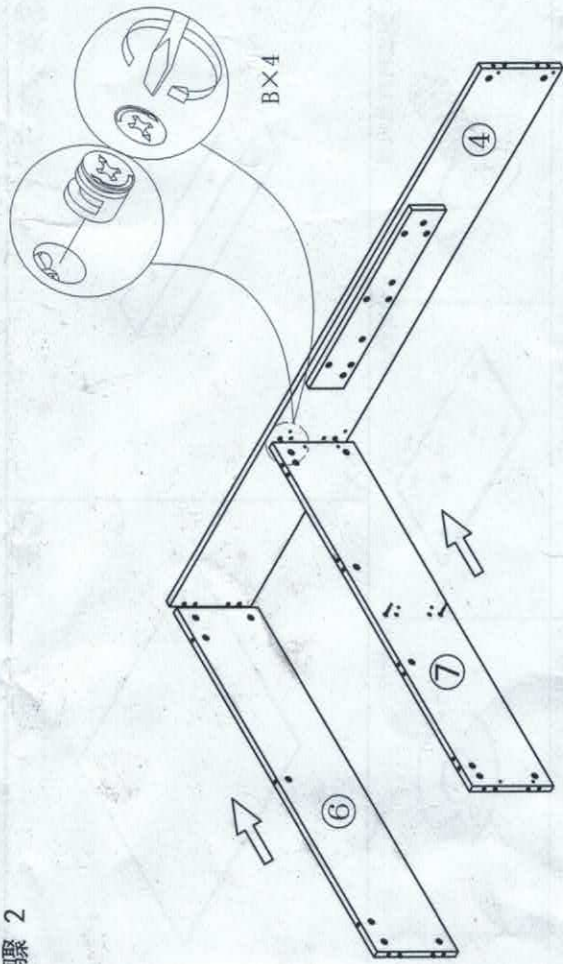

双人协助安装

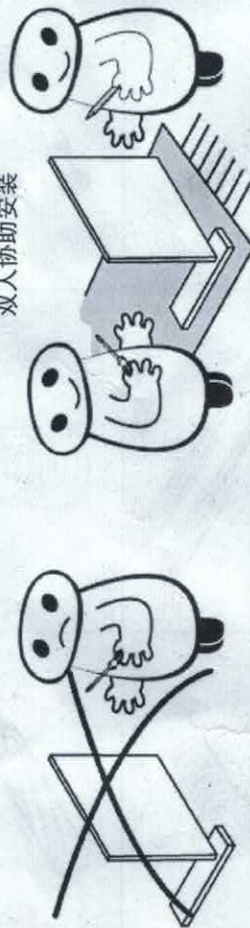

GCON 志光
400-870-9808

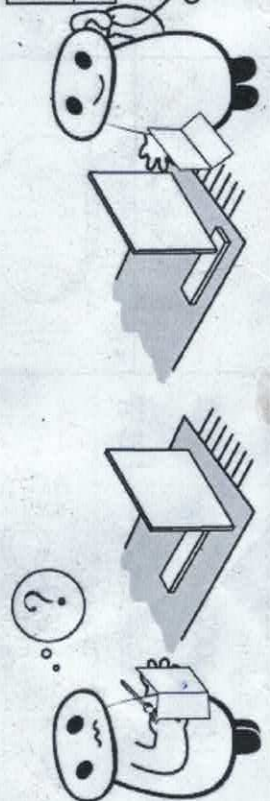

步骤 3

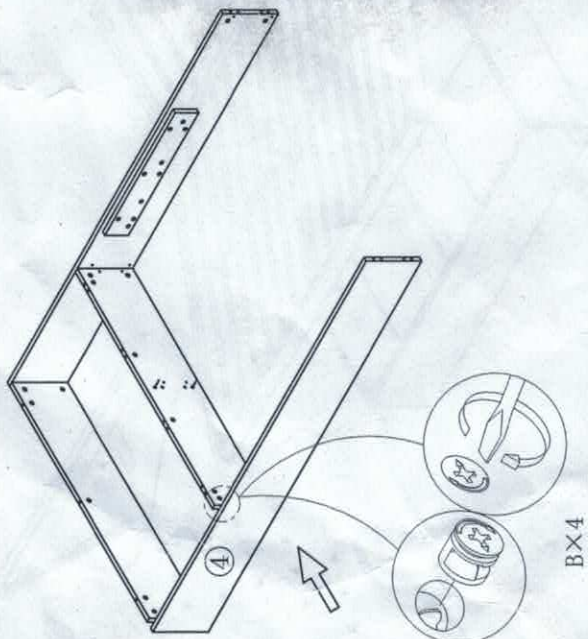

步骤 4

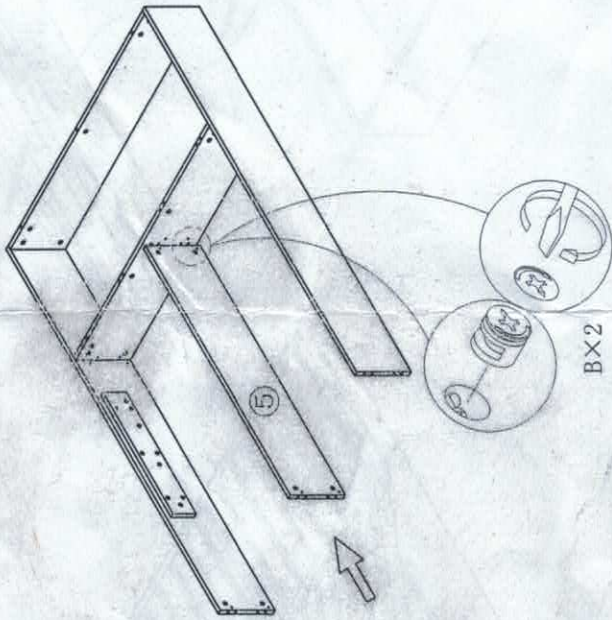

步骤 5

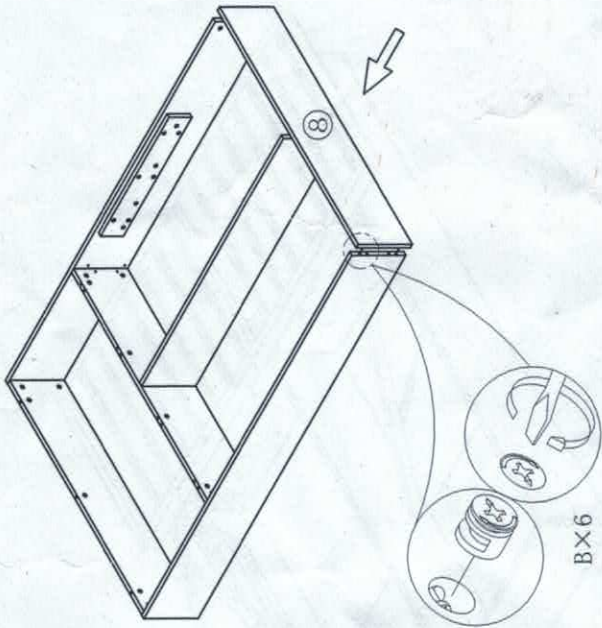

步骤 6

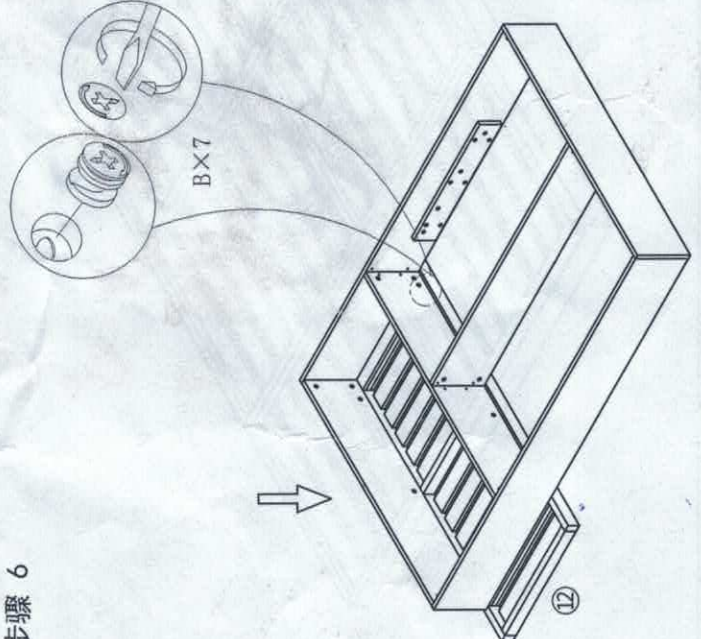

步骤 7

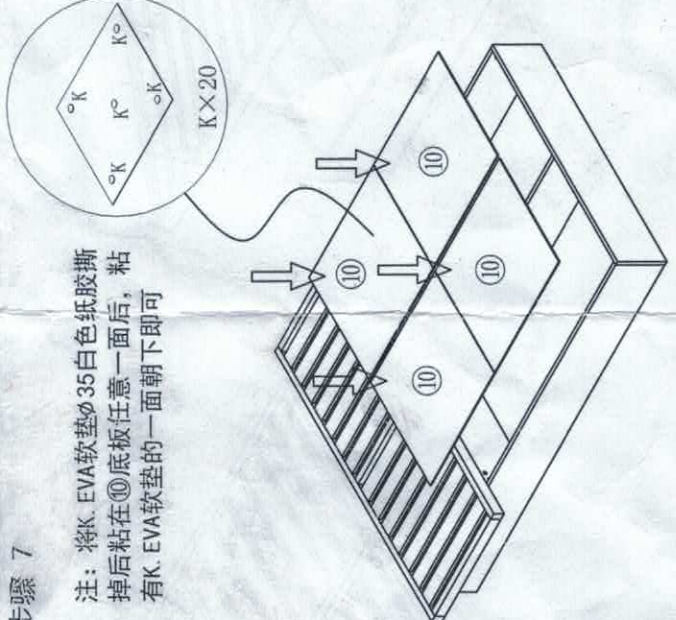

步骤 8

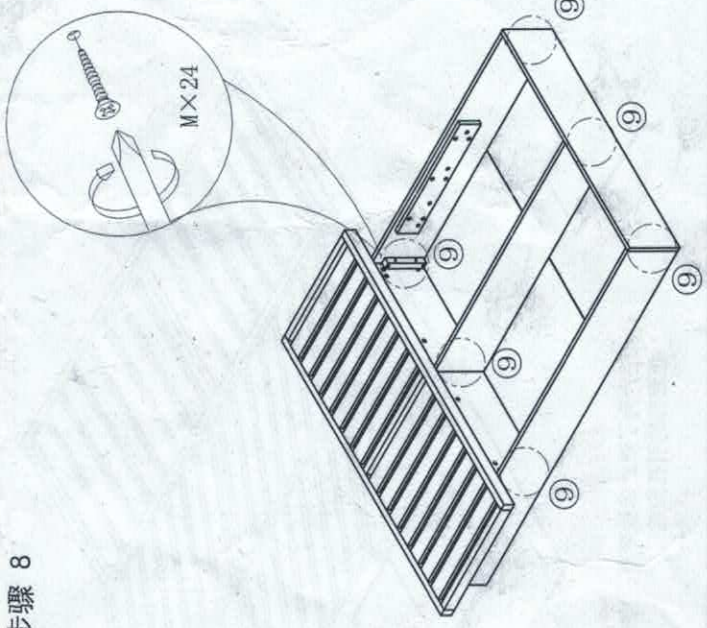

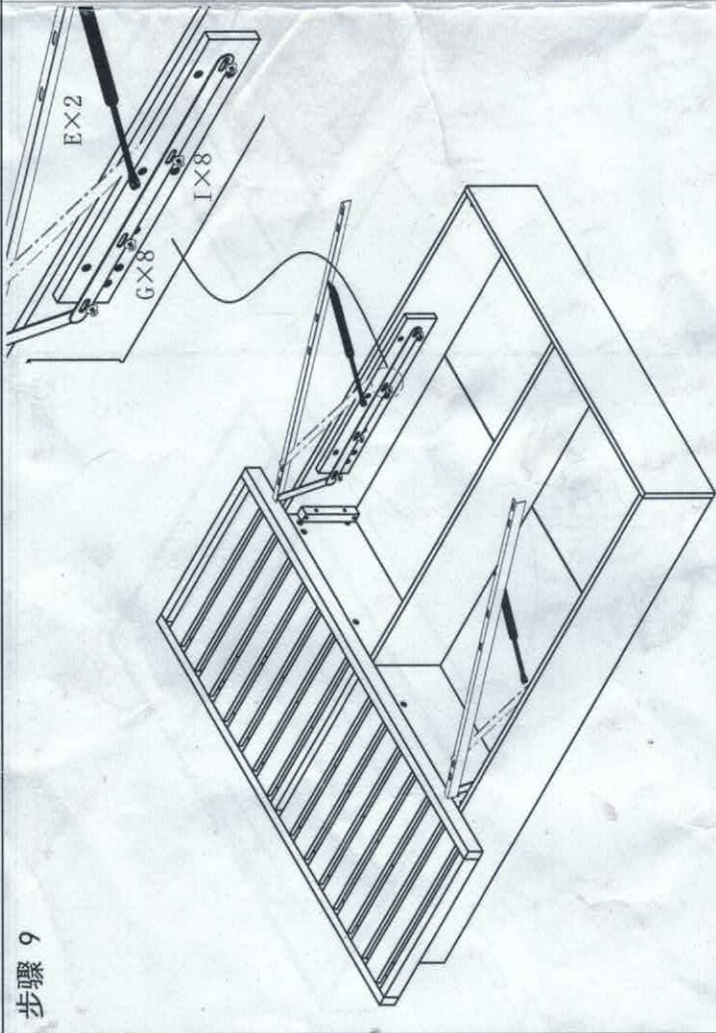

步骤 9

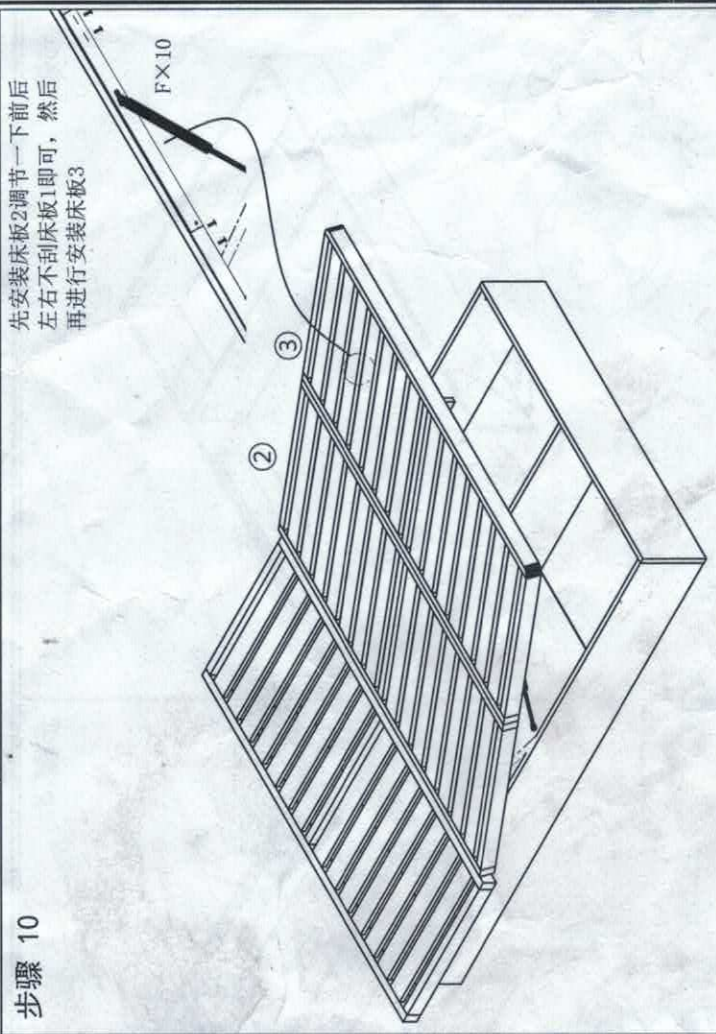

步骤 10

先安装床板2调节一下前后左右不刮床板1即可，然后再进行安装床板3

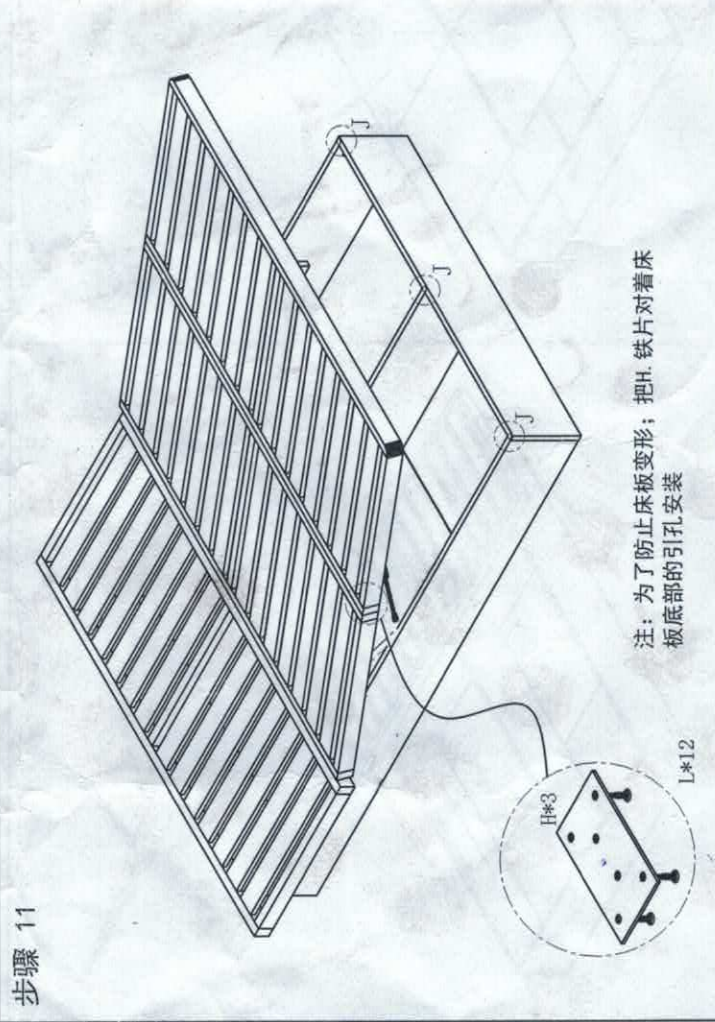

步骤 11

注：为了防止床板变形；把H. 铁片对着床板底部的引孔安装

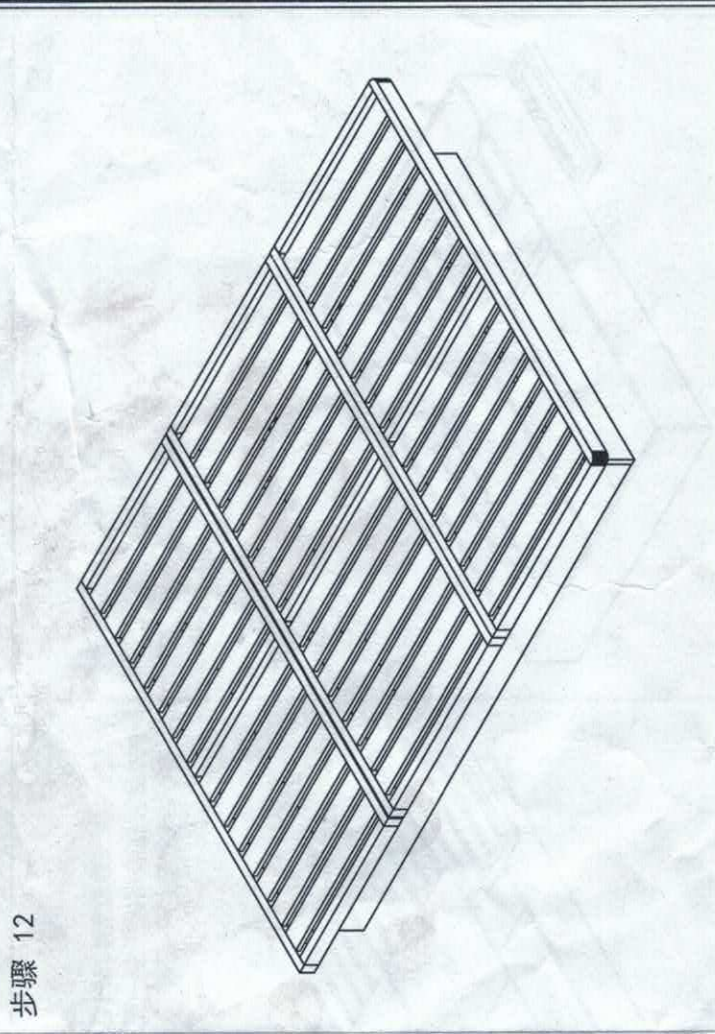

步骤 12