

ASSEMBLY INSTRUCTION

A



M6x12

x12

B



M6

x12

C



x1

STEP 1

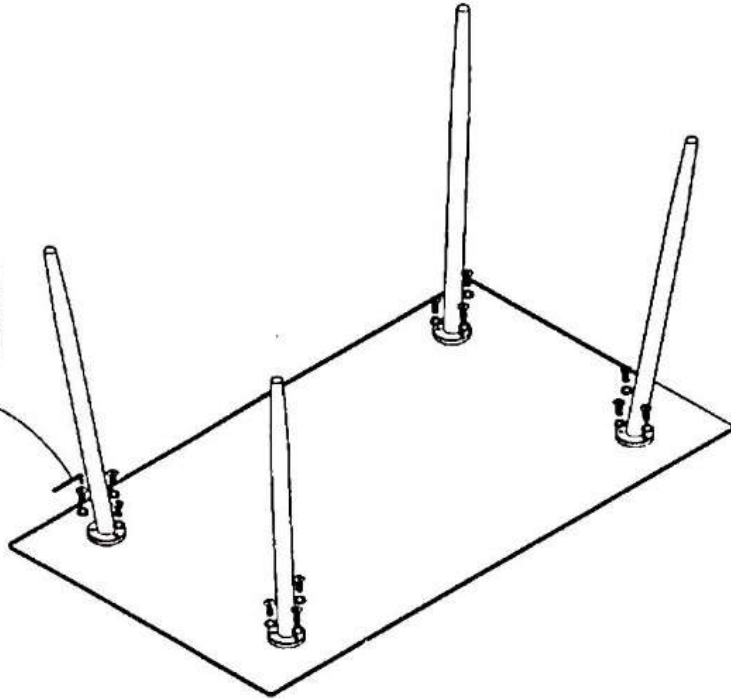
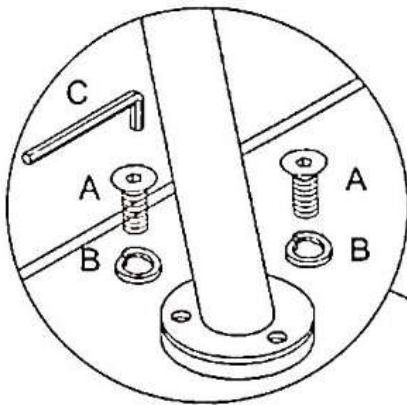

STEP 2

