

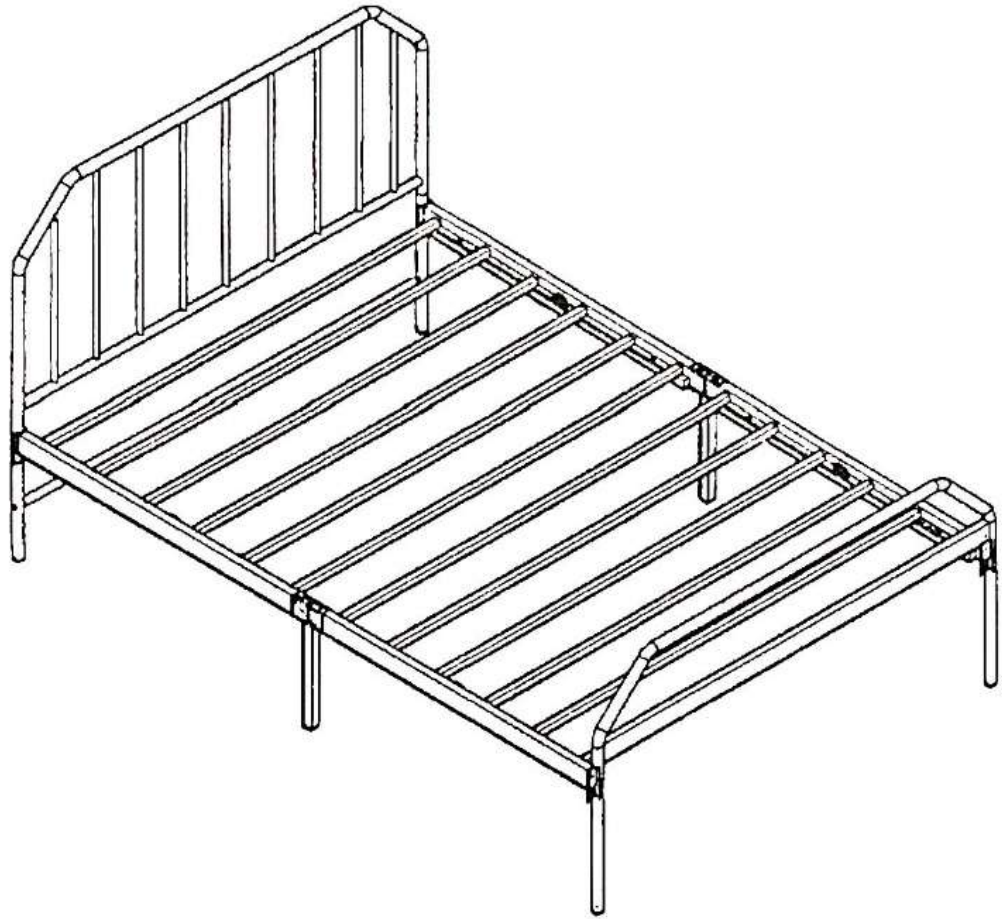

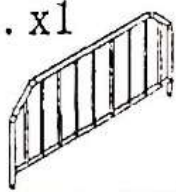







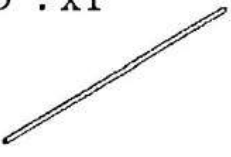

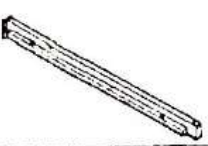

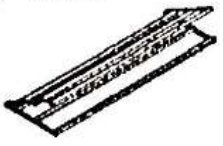

ASSEMBLY INSTRUCTION



<p>A . x1</p> 	<p>B . x1</p> 	<p>C . x2</p> 	<p>D . x1</p> 	<p>E . x2</p> 
<p>F . x2</p> 	<p>H . x2</p> 	<p>J . x2</p> 		
<p>1 . M8x40mm x8</p> 	<p>2 . M6x60mm x4</p> 	<p>3 . M6x40mm x2</p> 	<p>4 . M6x16mm x8</p> 	<p>5 . M8 x8</p> 
<p>6 . M8 x4</p> 	<p>7 . M6 x4</p> 	<p>8 . M5 x1</p> 	<p>9 . M10 x1</p> 	<p>10 . M12 x1</p> 

ASSEMBLY INSTRUCTION

1

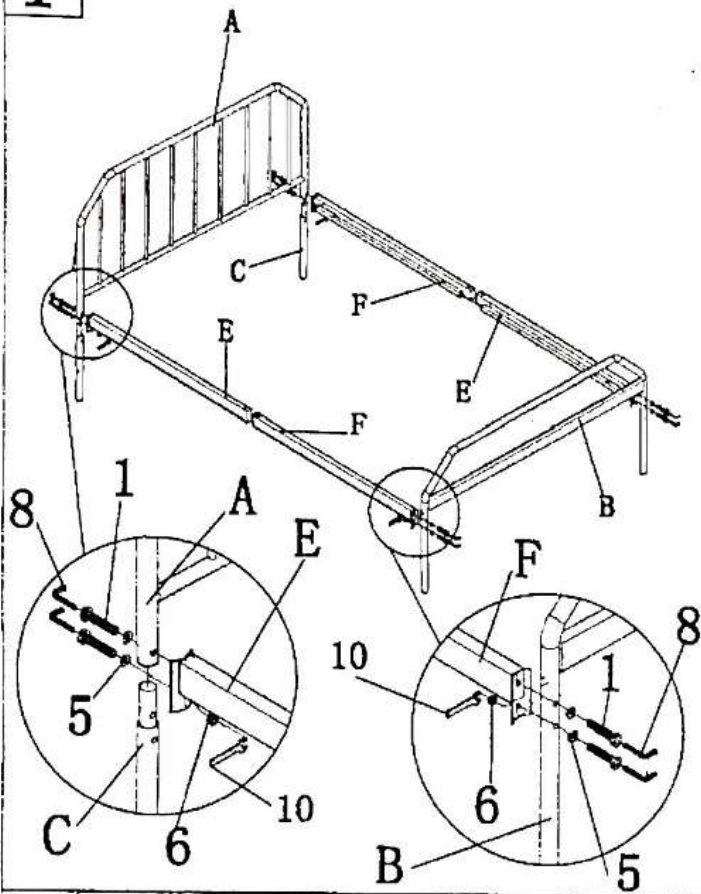

2

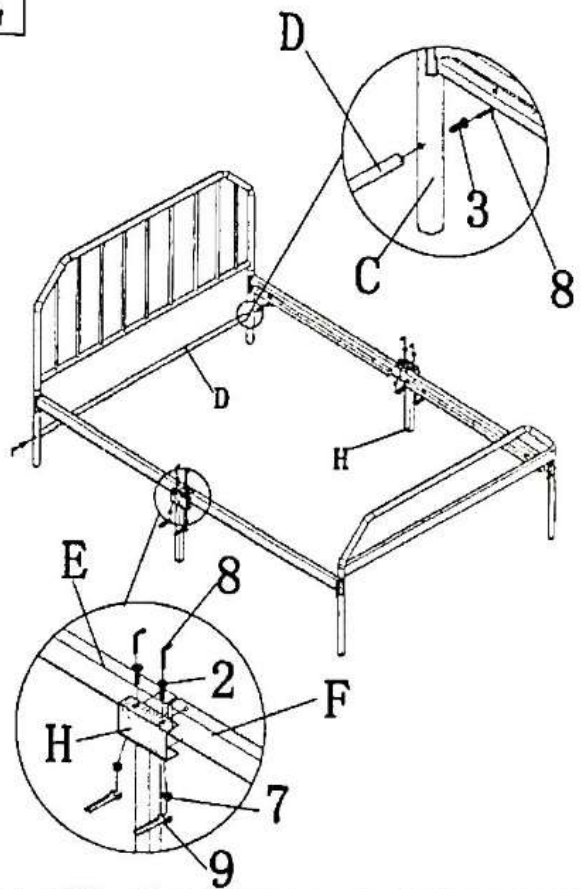

3

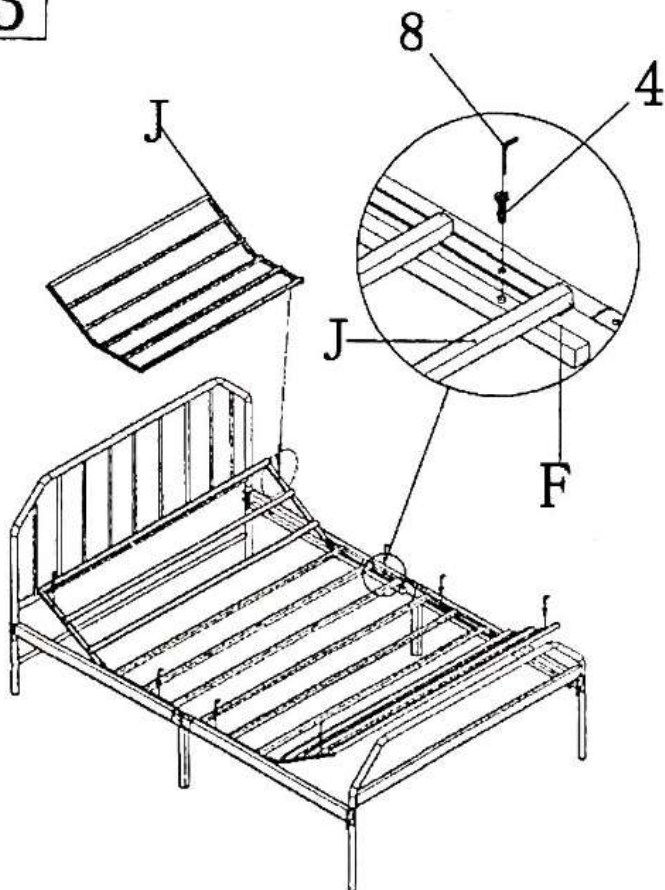

4

