

# ASSEMBLY INSTRUCTION

ITEM NO.:2273

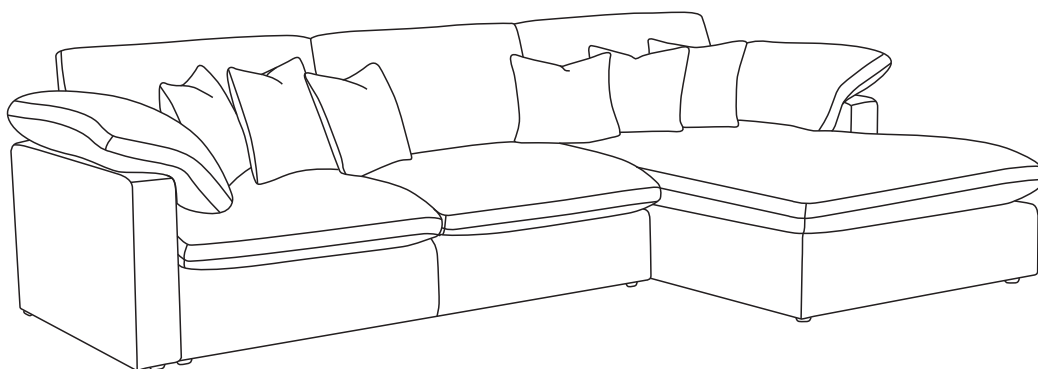

## PARTS LIST

<b>A</b> X1	<b>B</b> X1	<b>C</b> X2	<b>D</b> X1	<b>E</b> X1	<b>F</b> X1
<b>G</b> X2	<b>H</b> X1	<b>I</b> X2	<b>J</b> X1	<b>K</b> X2	<b>L</b> X6

## HARDWARE LIST

<b>1</b> X15	

BOX-1

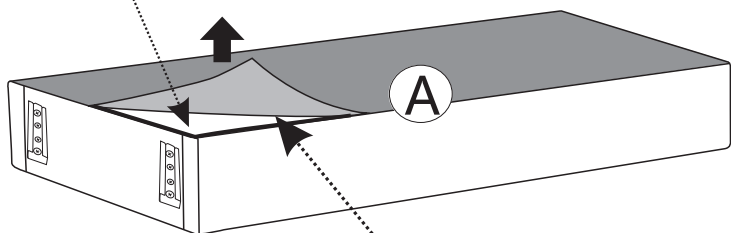
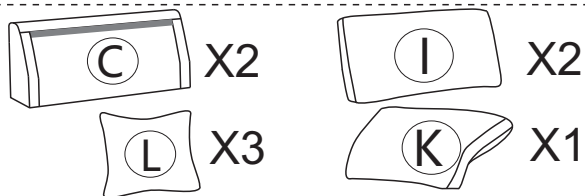

BOX-2

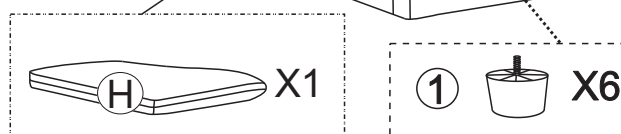
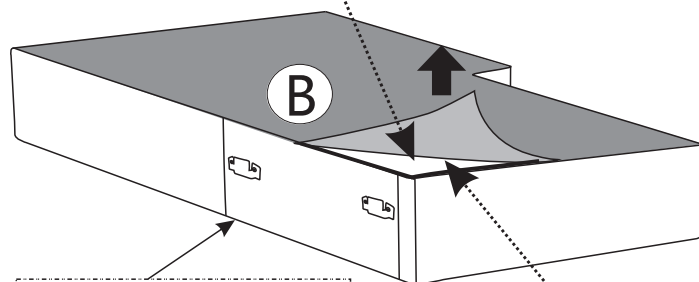
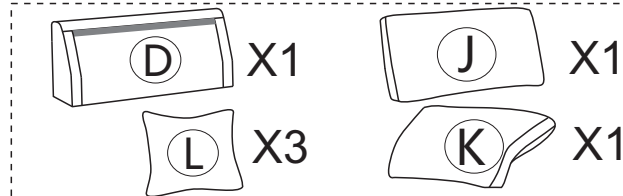

BOX-3

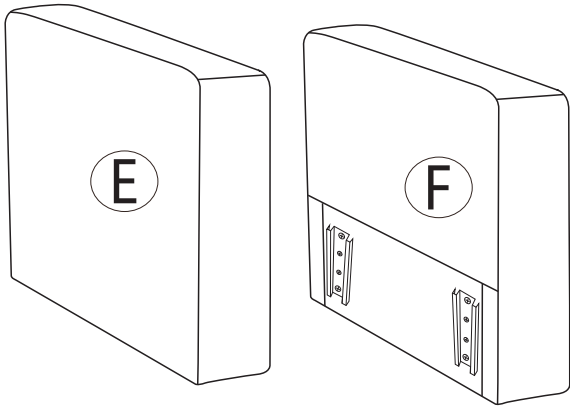

Step1

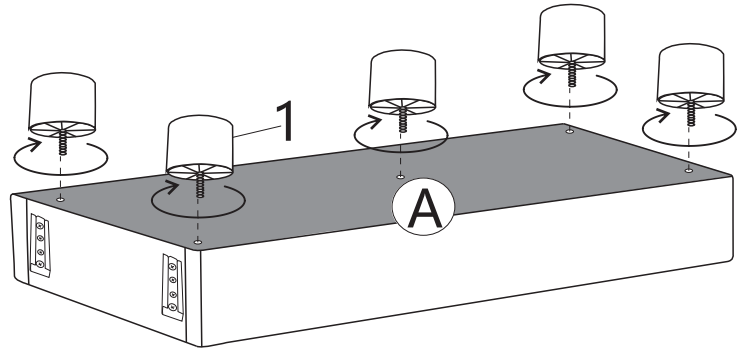

Step2

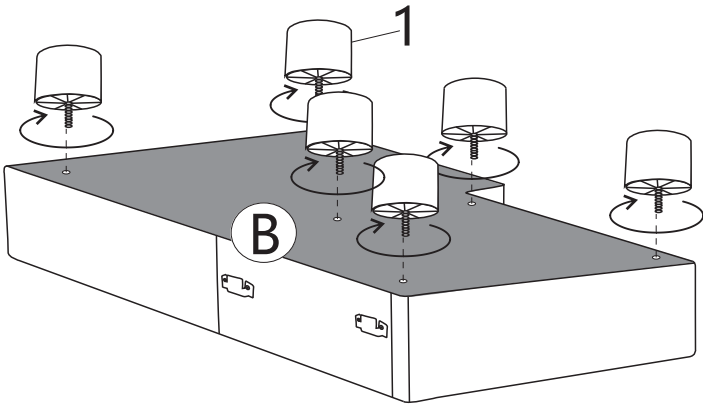

Step3

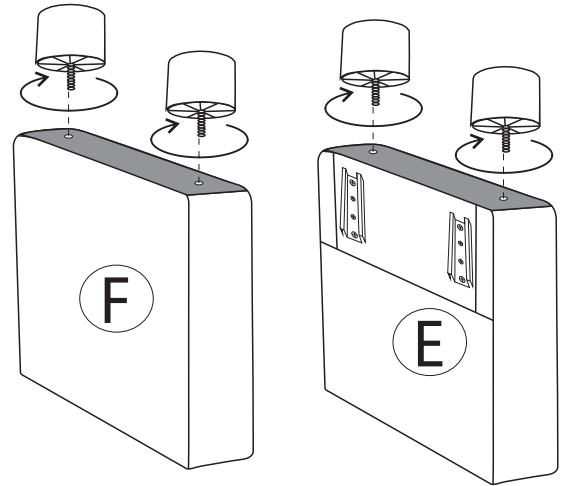

Step4

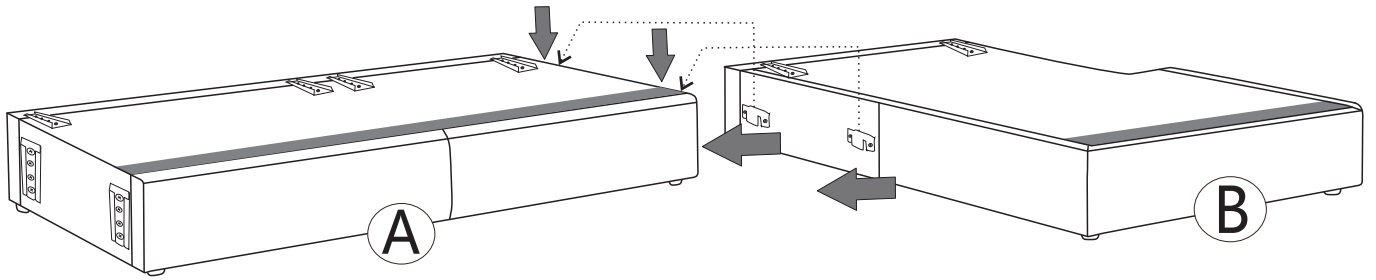

Step5

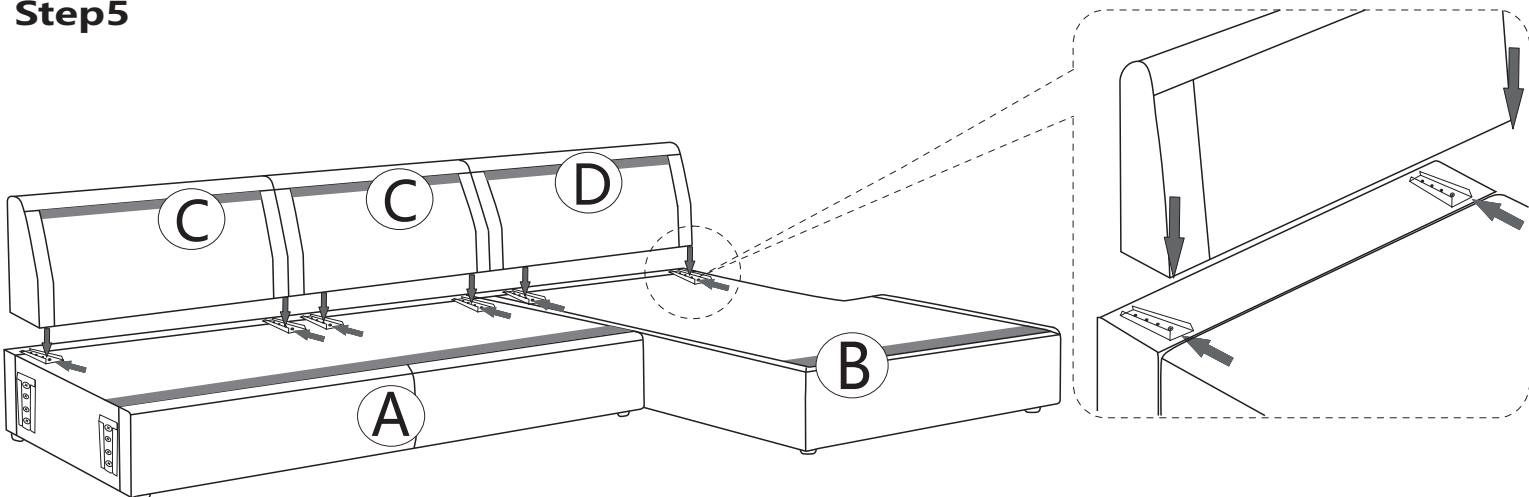

### Step6

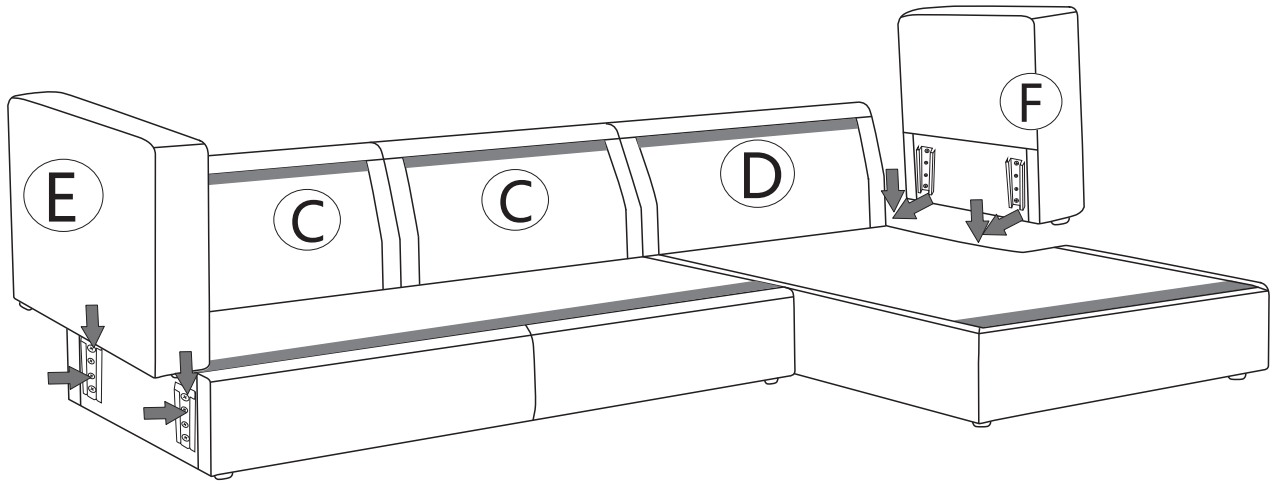

### Step7

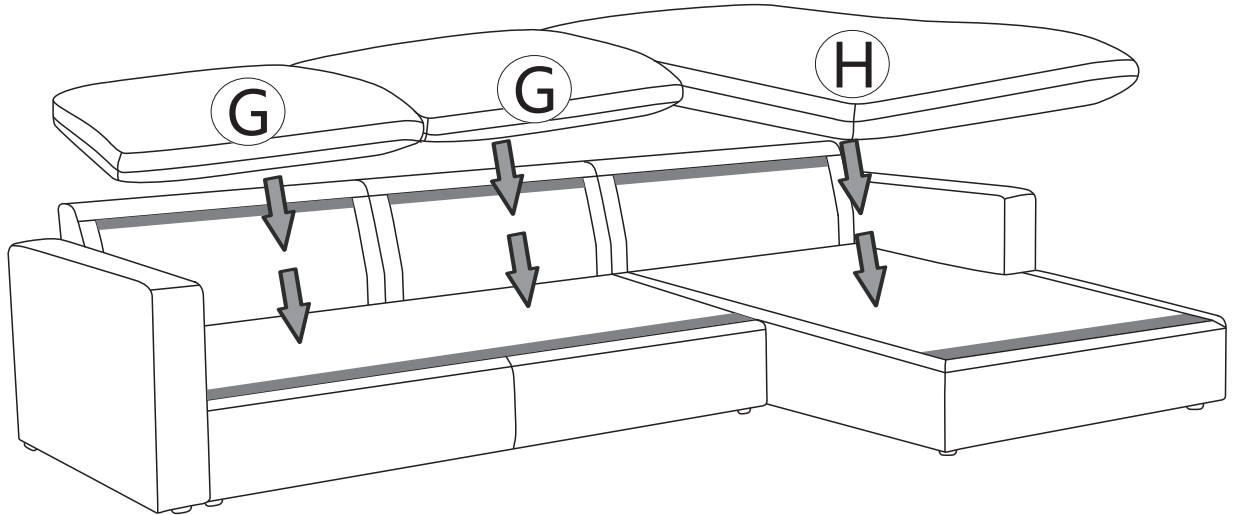

### Step8

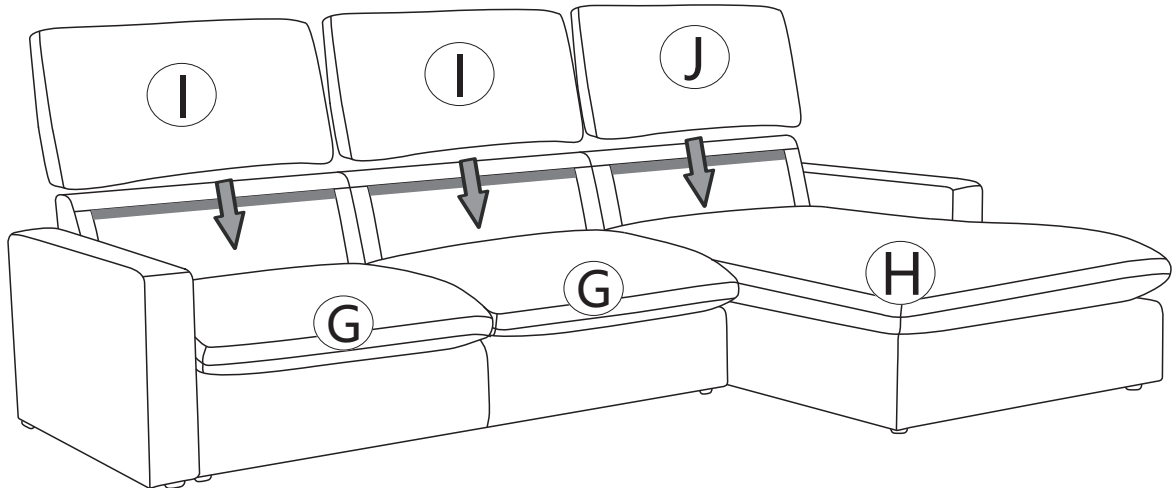

### Step9

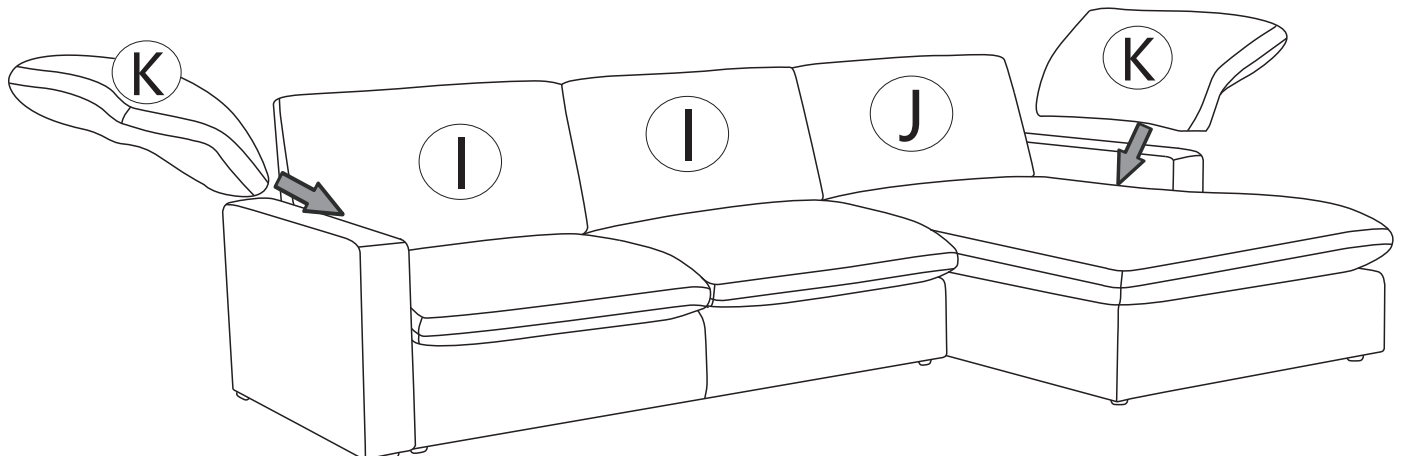

**Step 10**

